

ADVANCED JET

AJ-1000 Setup Guide

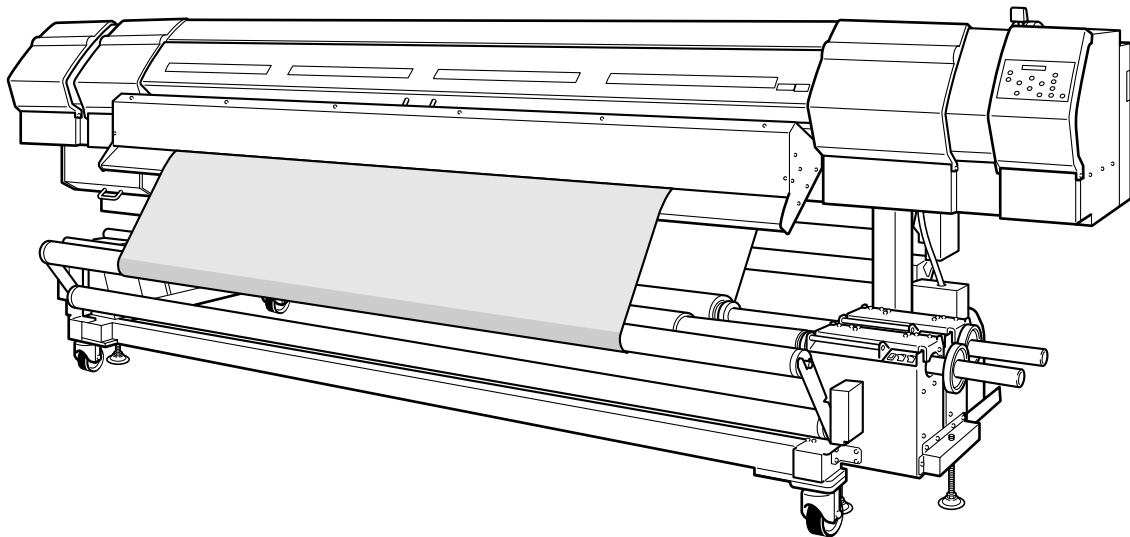



Read this first.

This describes the setup tasks and important conditions about the installation location that must be met in order to enable use of this machine.

Thank you very much for purchasing this product.

- To ensure correct and safe usage with a full understanding of this product's performance, please be sure to read through this manual completely and store it in a safe location.
- Unauthorized copying or transferral, in whole or in part, of this manual is prohibited.
- The contents of this operation manual and the specifications of this product are subject to change without notice.
- The operation manual and the product have been prepared and tested as much as possible. If you find any misprint or error, please inform us.
- Roland DG Corp. assumes no responsibility for any direct or indirect loss or damage which may occur through use of this product, regardless of any failure to perform on the part of this product.
- Roland DG Corp. assumes no responsibility for any direct or indirect loss or damage which may occur with respect to any article made using this product.

Contents

 To Ensure Safe Use	3
 Pour utiliser en toute sécurité	11
Setup Guide	19
1. Installation	20
Emplacement and Installation Operations	20
Deciding On an Installation Site	21
Temperature and Humidity	22
Power Supply	22
Installation Space	22
2. Included Items	23
3. Removing the Packing Materials	24
4. Connecting the Cables	26
Connecting the Cables	26
5. Installing the Ink Cartridges	27
Filling with Ink for the First Time	27

ENERGY STAR is a U.S. registered mark.
Company names and product names are trademarks or registered trademarks of their respective holders.

Copyright© 2005 Roland DG Corporation

<http://www.rolanddg.com/>



 ***To Ensure Safe Use***





To Ensure Safe Use

Improper handling or operation of this machine may result in injury or damage to property. Points which must be observed to prevent such injury or damage are described as follows.

About WARNING and CAUTION Notices

 WARNING	Used for instructions intended to alert the user to the risk of death or severe injury should the unit be used improperly.
 CAUTION	Used for instructions intended to alert the user to the risk of injury or material damage should the unit be used improperly. * Material damage refers to damage or other adverse effects caused with respect to the home and all its furnishings, as well to domestic animals or pets.

About the Symbols

	The  symbol alerts the user to important instructions or warnings. The specific meaning of the symbol is determined by the design contained within the triangle. The symbol at left means "danger of electrocution."
	The  symbol alerts the user to items that must never be carried out (are forbidden). The specific thing that must not be done is indicated by the design contained within the circle. The symbol at left means the unit must never be disassembled.
	The  symbol alerts the user to things that must be carried out. The specific thing that must be done is indicated by the design contained within the circle. The symbol at left means the power-cord plug must be unplugged from the outlet.

 **Incorrect operation may cause injury**

 **WARNING**

 **Be sure to follow the operation procedures described in this documentation. Never allow anyone unfamiliar with the usage or handling of the machine to touch it.**
Incorrect usage or handling may lead to an accident.

 **Keep children away from the machine.**
The machine includes areas and components that pose a hazard to children and may result in injury, blindness, choking, or other serious accident.

 **Never operate the machine while tired or after ingesting alcohol or any medication.**
Operation requires unimpaired judgment. Impaired judgment may result in an accident.

 **Never use the machine for any purpose for which it is not intended, or use the machine in an undue manner that exceeds its capacity.**
Doing so may result in injury or fire.

 **For accessories (optional and consumable items, AC adapter, power cord, and the like), use only genuine articles compatible with this machine.**
Incompatible items may lead to an accident.

 **When attempting cleaning, maintenance, or attachment or detachment of optional items, follow the instructions given in this guide.**
Incorrect operation or handling may result in injury or electrical shock.

 **Never attempt to disassemble, repair, or modify the machine.**
Doing so may result in fire, electrical shock, or injury. Entrust repairs to a trained service technician.

 **CAUTION**

 **Exercise caution to avoid being pinched or becoming caught.**
Inadvertent contact with certain areas may cause the hand or fingers to be pinched or become caught. Use care when performing operations.

 **Never attempt operation while wearing a necktie, necklace, or loose clothing. Bind long hair securely.**
Such items may become caught in the machine, resulting in injury.

 **Conduct operations in a clean, brightly lit location.**
Working in a location that is dark or cluttered may lead to an accident, such as becoming caught in the machine as the result of an inadvertent stumble.

 **Never climb or lean on the machine.**
The machine is not made to support a person. Climbing or leaning on the machine may dislodge components and cause a slip or fall, resulting in injury.

⚠ Danger of electrical short, shock, electrocution, or fire

⚠ WARNING

! Connect to an electrical outlet that complies with this machine's ratings (for voltage, frequency, and current). Incorrect voltage or insufficient current may cause fire or electrical shock.

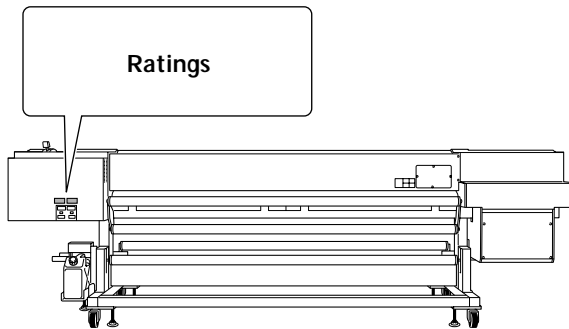

⊘ Never use out of doors or in any location where exposure to water or high humidity may occur. Never touch with wet hands. Doing so may result in fire or electrical shock.

⊘ Never allow any foreign object to get inside. Never expose to liquid spills. Inserting objects such as coins or matches or allowing beverages to be spilled into the ventilation ports may result in fire or electrical shock. If anything gets inside, immediately disconnect the power cord and contact your authorized Roland DG Corp. dealer.

⊘ Never place any flammable object nearby. Never use a combustible aerosol spray nearby. Never use in any location where gases can accumulate. Combustion or explosion may be a danger.

⚠ WARNING

! Handle the power cord, plug, and electrical outlet correctly and with care. Never use any article that is damaged. Using a damaged article may result in fire or electrical shock.

! When using an extension cord or power strip, use one that adequately satisfies the machine's ratings (for voltage, frequency, and current). Use of multiple electrical loads on a single electrical outlet or of a lengthy extension cord may cause fire.

⏚ Connect to ground. This can prevent fire or electrical shock due to current leakage in the event of malfunction.

! Position so that the power plug is within immediate reach at all times. This is to enable quick disconnection of the power plug in the event of an emergency. Install the machine next to an electrical outlet. Also, provide enough empty space to allow immediate access to the electrical outlet.

! If sparking, smoke, burning odor, unusual sound, or abnormal operation occurs, immediately unplug the power cord. Never use if any component is damaged. Continuing to use the machine may result in fire, electrical shock, or injury. Contact your authorized Roland DG Corp. dealer.

⚠ Important notes about the power cord, plug, and electrical outlet

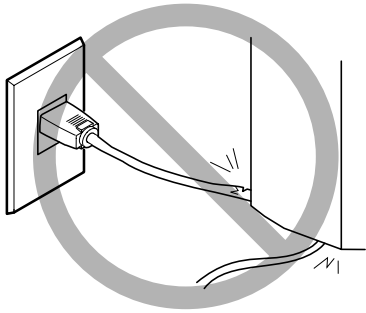

Never place any object on top or subject to damage.

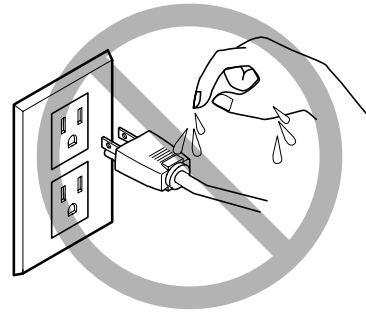

Never allow to get wet.

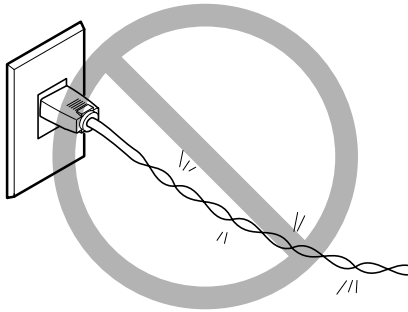

Never bend or twist with undue force.

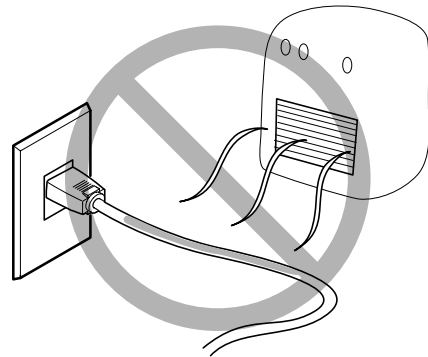

Never make hot.

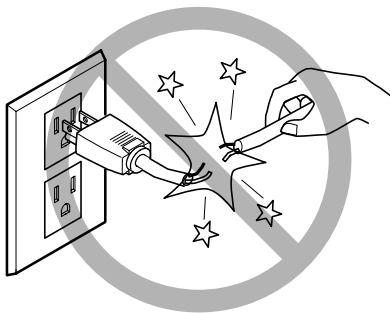

Never pull with undue force.

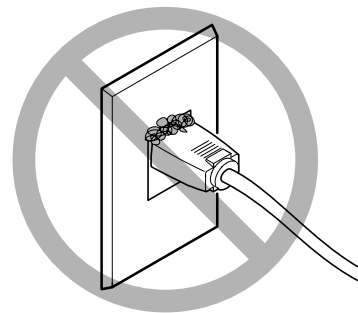

Dust may cause fire.

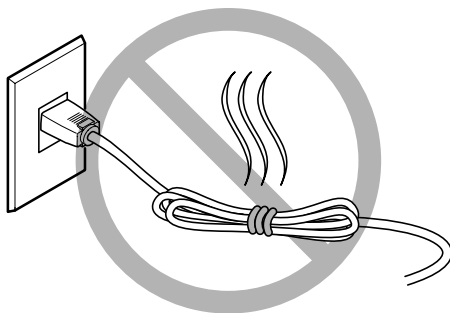

Never bundle, bind, or roll up.

 **Ink, cleaning fluid, and discharged fluid are flammable and toxic**

 **WARNING**

 **Keep open flame away from the work area.**
Ink and discharged fluid are flammable.

 **Never store ink, maintenance liquid, or discharged fluid in any of the following locations.**

- Any location exposed to open flame
- Any location where high temperature may occur
- Near bleach or any other such oxidizing agent or explosive material
- Any location within the reach of children

Fire may be a danger. Accidental ingestion by children may pose a health hazard.

 **Never place an ink cartridge in fire.**
Ink may flow out, catch fire, and spread fire to other nearby objects.

 **Never drink or sniff ink, maintenance liquid, or discharged fluid, or allow them to come in contact with the eyes or skin.**
Doing so may be hazardous to the health.

 **CAUTION**

 **Ensure adequate ventilation for the work area.**
Failing to perform ventilation may result in a health hazard or danger of combustion due to ink fumes.

 **Never allow an ink cartridge to be subjected to impact, and never attempt to disassemble.**
Ink may leak.

 **In the event of ingestion or physical distress**

- In the event of contact with the eyes, immediately flush with water for at least 15 minutes. If eye irritation continues, seek treatment by a physician.
- In the event of contact with skin, immediately wash with soap. If irritation or inflammation occur, seek treatment by a physician.
- In the event of ingestion, do not induce vomiting, and immediately seek treatment by a physician. Forcibly inducing vomiting may lead to danger of choking.
- If odor leads to physical distress, move to a well-ventilated location and rest quietly. If dizziness or nausea persists, seek treatment by a physician.

 This machine weighs 700 kg (1550 lb.). Media weighs 100 kg (220 lb.)

 **WARNING**

 **Entrust operations such as transportation, unloading, and emplacement to trained workers.**
Handling requires special equipment and training. Performing operations in an unreasonable manner may result in a major accident.

 **Install the machine in a location that is level, stable, and able to bear the weight of the machine.**
The total weight of the machine may reach 700 kg (1550 lb.) or more. Installation in an unsuitable location may cause a major accident, including tipover, fall, or collapse.

 **Be sure to anchor the stand to the floor.**
If the machine should begin to topple, a major accident may result, including crushing of the appendages or the body.

 **WARNING**

 **When loading or moving roll media, use lifting equipment, and exercise care to prevent falls.**
Attempting manual lifting of heavy media that taxes your strength may cause physical injury. Also, if dropped, such items may cause injury.

 **When storing roll media, implement adequate safety measures to ensure that the stored media will not roll, fall, or topple over.**
Danger exists of becoming pinned under the media and suffering serious injury.

 **Danger of fire, burns, or toxic gas emissions**

 **WARNING**

 **Caution: high temperatures.**
Areas such as the dryer become hot. Exercise caution to avoid fire or burns.

 **When printing is not being performed, remove any loaded media or switch off the power.**
The continued application of heat at a single location may cause the release of toxic gases from the media or pose a fire hazard.

 **WARNING**

 **Never use media that cannot withstand heat.**
Doing so may degrade the media, or may result in fire or the release of toxic gases.

⚠ Warning Labels

Warning labels are affixed to make areas of danger immediately clear. The meanings of these labels are as follows. Be sure to heed their warnings.

Also, never remove the labels or allow them to become obscured.

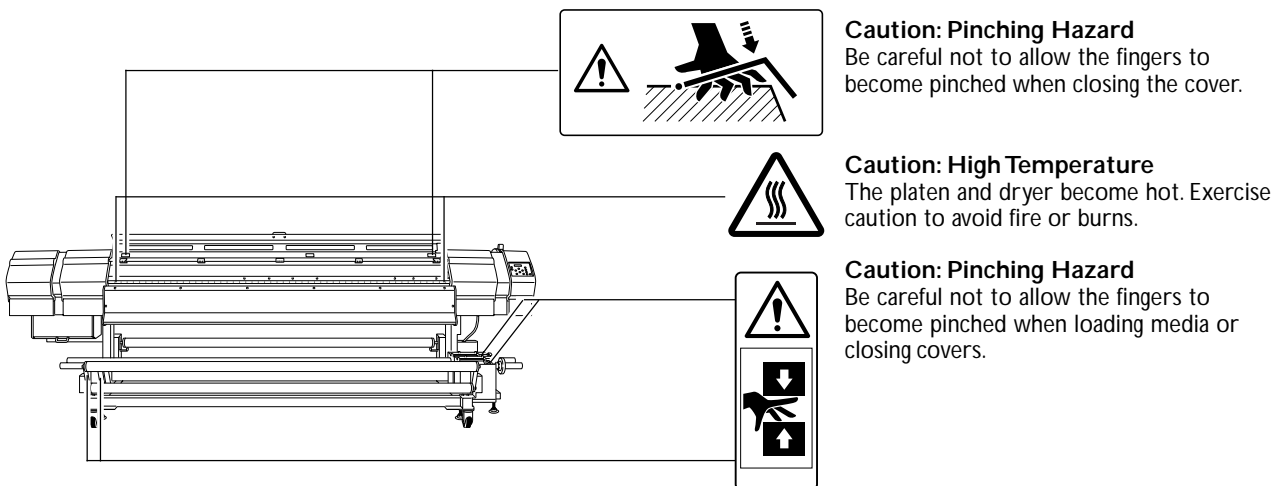
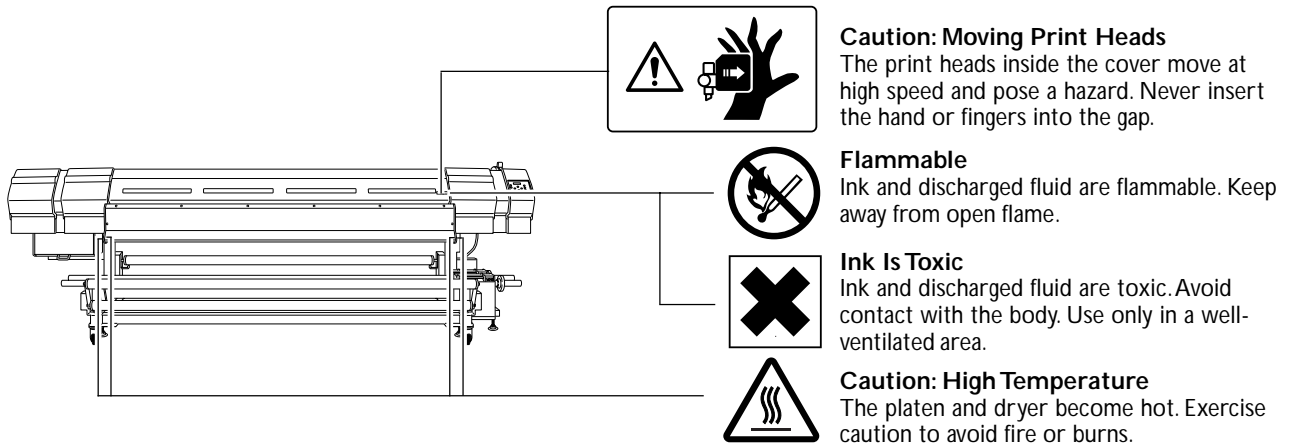

Flammable

Ink and discharged fluid are flammable. Keep away from open flame.



Ink Is Toxic

Ink and discharged fluid are toxic. Avoid contact with the body. Use only in a well-ventilated area.

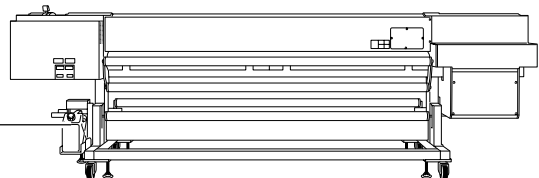



 ***Pour utiliser en
toute sécurité***









Pour utiliser en toute sécurité

La manipulation ou l'utilisation inadéquates de cet appareil peuvent causer des blessures ou des dommages matériels. Les précautions à prendre pour prévenir les blessures ou les dommages sont décrites ci-dessous.

Avis sur les avertissements

 ATTENTION	Utilisé pour avertir l'utilisateur d'un risque de décès ou de blessure grave en cas de mauvaise utilisation de l'appareil.
 PRUDENCE	Utilisé pour avertir l'utilisateur d'un risque de blessure ou de dommage matériel en cas de mauvaise utilisation de l'appareil. * Par dommage matériel, il est entendu dommage ou tout autre effet indésirable sur la maison, tous les meubles et même les animaux domestiques.

À propos des symboles

	Le symbole  attire l'attention de l'utilisateur sur les instructions importantes ou les avertissements. Le sens précis du symbole est déterminé par le dessin à l'intérieur du triangle. Le symbole à gauche signifie "danger d'électrocution".
	Le symbole  avertit l'utilisateur de ce qu'il ne doit pas faire, ce qui est interdit. La chose spécifique à ne pas faire est indiquée par le dessin à l'intérieur du cercle. Le symbole à gauche signifie que l'appareil ne doit jamais être démonté.
	Le symbole  prévient l'utilisateur sur ce qu'il doit faire. La chose spécifique à faire est indiquée par le dessin à l'intérieur du cercle. Le symbole à gauche signifie que le fil électrique doit être débranché de la prise.

⚠ L'utilisation incorrecte peut causer des blessures

⚠ ATTENTION

 **S'assurer de suivre les procédures d'utilisation décrites dans la documentation. Ne jamais permettre à quiconque ne connaît pas le fonctionnement ou la manutention de l'appareil de le toucher.** L'utilisation ou la manutention incorrectes peuvent causer un accident.

 **Garder les enfants loin de l'appareil.** L'appareil comporte des zones et des composants qui présentent un danger pour les enfants et qui pourraient causer des blessures, la cécité, la suffocation ou d'autres accidents graves.

 **Ne jamais faire fonctionner l'appareil après avoir consommé de l'alcool ou des médicaments, ou dans un état de fatigue.** L'utilisation de l'appareil exige un jugement sans faille. L'utilisation avec les facultés affaiblies pourrait entraîner un accident.

 **Ne jamais utiliser l'appareil à des fins autres que celles pour lesquelles il est conçu. Ne jamais l'utiliser de manière abusive ou d'une manière qui dépasse sa capacité.** Le non-respect de cette consigne peut causer des blessures ou un incendie.

 **Utiliser uniquement des accessoires d'origine (accessoires en option, articles consommables, adaptateur CA, câble d'alimentation et autres articles semblables), compatibles avec l'appareil.** Les articles incompatibles risquent de causer des accidents.

 **Suivre les instructions données dans ce guide pour le nettoyage, l'entretien, l'installation ou le retrait des accessoires en option.** La manipulation ou l'utilisation incorrectes risquent de causer des blessures ou un choc électrique.

⚠ ATTENTION

 **Ne jamais tenter de démonter, de réparer ou de modifier l'appareil.** Le non-respect de cette consigne risque de provoquer un incendie, un choc électrique ou des blessures. Confier les réparations à un technicien ayant la formation requise.

⚠ PRUDENCE

 **Faire preuve de prudence pour éviter l'écrasement ou le coincement.** La main ou les doigts peuvent être écrasés ou coincés s'ils entrent en contact avec certaines surfaces par inadvertance. Faire preuve de prudence pendant l'utilisation de l'appareil.

 **Ne jamais faire fonctionner l'appareil si on porte une cravate, un collier ou des vêtements amples. Bien attacher les cheveux longs.** Ces vêtements ou ces objets peuvent être coincés dans l'appareil, ce qui causerait des blessures.

 **Utiliser l'appareil dans un endroit propre et bien éclairé.** Travailler dans un endroit sombre ou encombré peut causer un accident; l'utilisateur risque, par exemple, de trébucher malencontreusement et d'être coincé par une partie de l'appareil.

 **Ne jamais grimper ni s'appuyer sur la machine.** La machine n'est pas conçue pour supporter le poids d'une personne. Grimper ou s'appuyer sur la machine peut déplacer des éléments et causer un faux pas ou une chute, ce qui causerait des blessures.

⚠ Risque de décharge ou de choc électrique, d'électrocution ou d'incendie

⚠ ATTENTION



Brancher à une prise électrique conforme aux caractéristiques de cet appareil (tension, fréquence et courant).

Une tension incorrecte ou un courant insuffisant peuvent causer un incendie ou un choc électrique.

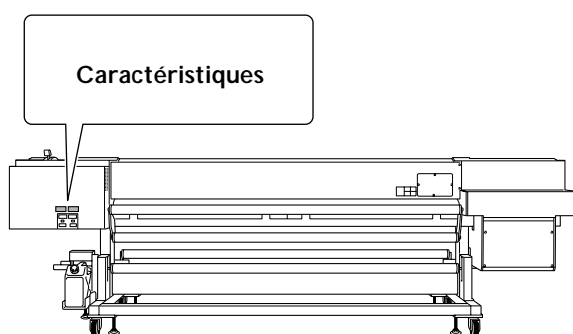

Ne jamais utiliser à l'extérieur ni à un endroit où l'appareil risque d'être exposé à de l'eau ou à une humidité élevée. Ne jamais toucher l'appareil avec des mains mouillées.

Le non-respect de cette consigne risque de provoquer un incendie ou un choc électrique.



Ne jamais insérer d'objet étranger dans l'appareil. Ne jamais exposer l'appareil aux déversements de liquides.

L'insertion d'objets comme des pièces de monnaie ou des allumettes, ou le déversement de liquides dans les orifices de ventilation peuvent causer un incendie ou un choc électrique. Si un objet ou du liquide s'infiltré dans l'appareil, débrancher immédiatement le câble d'alimentation et communiquer avec le représentant Roland DG Corp. autorisé.



Ne jamais placer d'objet inflammable à proximité de l'appareil. Ne jamais utiliser de produit inflammable en aérosol à proximité de l'appareil. Ne jamais utiliser l'appareil dans un endroit où des gaz peuvent s'accumuler.

Une combustion ou une explosion pourraient se produire.

⚠ ATTENTION



Manipuler le câble d'alimentation, la fiche et la prise électrique correctement et avec soin.

Ne jamais utiliser un article endommagé, car cela pourrait causer un incendie ou un choc électrique.



Si une rallonge ou une bande d'alimentation électrique sont utilisées, s'assurer qu'elles correspondent aux caractéristiques de l'appareil (tension, fréquence et courant).

L'utilisation de plusieurs charges électriques sur une prise unique ou une longue rallonge peut causer un incendie.



Mise à la terre.

La mise à la terre peut prévenir un incendie ou un choc électrique dus à une fuite de courant en cas de défaillance.



Placer l'appareil de façon à ce que la fiche soit facile d'accès en tout temps.

Ainsi, l'appareil pourra être débranché rapidement en cas d'urgence. Installer l'appareil près d'une prise électrique. En outre, prévoir suffisamment d'espace pour que la prise électrique soit facile d'accès.



S'il se produit des étincelles, de la fumée, une odeur de brûlé, un bruit inhabituel ou un fonctionnement anormal, débrancher immédiatement le câble d'alimentation. Ne jamais utiliser si un composant est endommagé.

Continuer à utiliser l'appareil peut causer un incendie, un choc électrique ou des blessures. Communiquer avec le représentant Roland DG Corp. Autorisé.

⚠ Remarques importantes à propos du câble d'alimentation, de la fiche et de la prise électrique

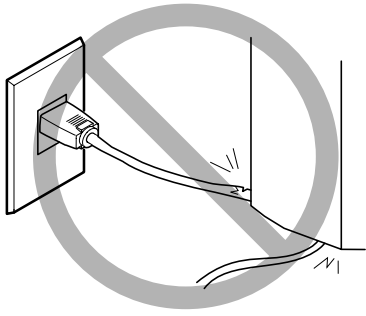

Ne jamais déposer aucun objet sur le câble, sur la fiche ou sur la prise car cela risque de les endommager.

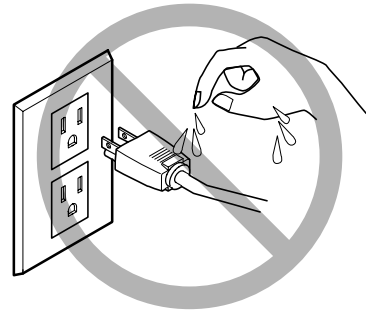

Ne jamais laisser l'eau toucher le câble, la fiche ou la prise.

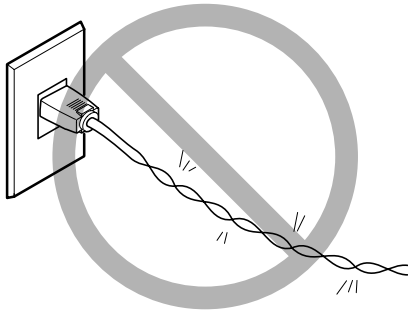

Ne jamais plier ni tordre le câble avec une force excessive.

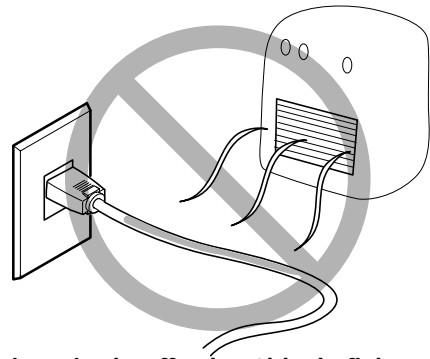

Ne jamais chauffer le câble, la fiche ou la prise.

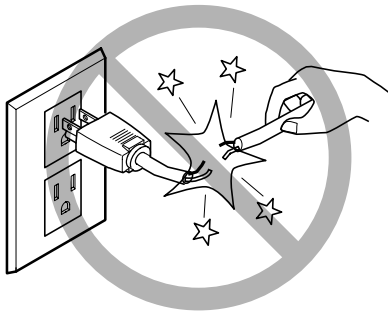

Ne jamais tirer sur le câble ou la fiche avec une force excessive.

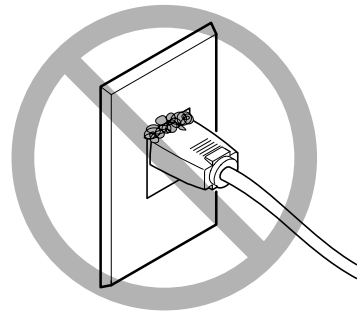

La poussière peut causer un incendie.

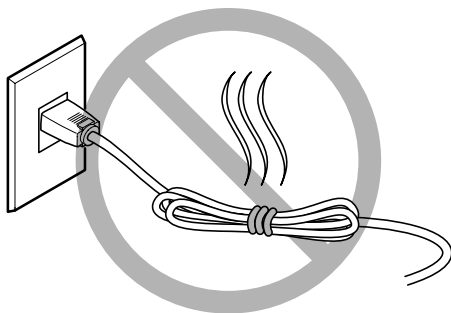

Ne jamais plier ni enrouler le câble.

 **L'encre, les liquides nettoyants et les liquides usés sont inflammables et toxiques**

 **ATTENTION**

 **Ne pas approcher une flamme nue de l'espace de travail.**
L'encre et les liquides usés sont inflammables.

 **Ne jamais entreposer d'encre, de liquide de nettoyage ou d'entretien ni de liquides usés dans les endroits suivants :**

- un endroit exposé à une flamme nue;
- un endroit où il y a risque de température élevée;
- près d'eau de Javel, d'un autre agent d'oxydation ou de matériel explosif;
- tout endroit à la portée d'enfants.

Il y a risque d'incendie. L'ingestion accidentelle par un enfant peut présenter un risque pour la santé.

 **Ne jamais incinérer une cartouche d'encre.**
De l'encre pourrait couler, s'enflammer et le feu se répandre à des objets proches.

 **Ne jamais boire l'encre, le liquide de nettoyage ou d'entretien ni les liquides usés, ne pas en respirer les vapeurs et ne pas laisser ces produits entrer en contact avec les yeux ou la peau.**
Cela est dangereux pour la santé.

 **PRUDENCE**

 **S'assurer que le lieu de travail est bien aéré.**
L'absence d'aération adéquate peut créer une situation dangereuse pour la santé ou un risque de combustion à cause des vapeurs qui émanent de l'encre.

 **Ne jamais soumettre une cartouche d'encre à des chocs. Ne jamais tenter d'ouvrir une cartouche d'encre.**
De l'encre pourrait s'échapper.

 **En cas d'ingestion ou de trouble physique**

- En cas de contact avec les yeux : rincer immédiatement et abondamment à l'eau courante pendant au moins 15 minutes. Si les yeux sont toujours irrités, consulter un médecin.
- En cas de contact avec la peau : laver immédiatement à l'eau et au savon. En cas d'irritation ou d'inflammation de la peau : consulter un médecin.
- En cas d'ingestion : ne pas provoquer le vomissement et demander immédiatement l'aide d'un médecin. Provoquer le vomissement peut créer un risque de suffocation.
- Si l'odeur cause un trouble physique, amener la personne dans un endroit bien aéré et la faire se reposer. Si l'étourdissement ou la nausée persistent, consulter un médecin.

**⚠ Le poids de cet appareil est de 700 kg (1550 lb.)
Le poids du support est de 100 kg (220 lb.)**

⚠ ATTENTION



Confier les opérations comme le transport, le déchargement et la mise en place à des travailleurs qui ont reçu la formation requise.

La manutention exige de la formation et de l'équipement spécialisés. Tenter de procéder à ces opérations de manière intempestive peut provoquer un accident grave.



Installer l'appareil à un endroit stable et plat et capable de supporter son poids.

Le poids total de l'appareil peut être d'au moins 700 kg (1550 lb.). Installer l'appareil à un endroit inapproprié peut provoquer un accident grave comme le renversement, la chute ou l'écrasement.



S'assurer d'ancrer la base de l'appareil au sol.

Si l'appareil devait commencer à basculer, il s'ensuivrait un accident grave, par exemple l'écrasement de membres ou du corps.

⚠ ATTENTION



Lors du chargement ou du déplacement de support en rouleau, utiliser de l'équipement de levage et faire preuve de prudence pour éviter les chutes.

Tenter de soulever manuellement des objets trop lourds peut causer des blessures. En outre, si ces objets sont échappés, ils peuvent causer des blessures.



Prendre les mesures de sécurité adéquates pour l'entreposage des rouleaux de support pour s'assurer qu'ils ne rouleront pas, ne tomberont pas et ne se renverseront pas.

Il y a risque d'être écrasé par le support et de subir des blessures graves.

⚠ Risque d'incendie, de brûlures ou d'émissions de gaz toxiques

⚠ ATTENTION



Attention : températures élevées.

Les zones comme le séchoir chauffent. Faire preuve de prudence pour éviter un incendie ou des brûlures.



Quand aucun travail d'impression n'est en cours, retirer tout support de l'appareil ou couper l'alimentation électrique.

L'application continue de chaleur à un point unique peut causer l'émission de gaz toxiques ou créer un risque d'incendie.

⚠ ATTENTION



Ne jamais utiliser un support qui ne peut pas supporter la chaleur.

L'utilisation d'un support qui ne supporte pas la chaleur peut détériorer le support, créer un risque d'incendie ou causer l'émission de gaz toxiques.

⚠ Vignettes d'avertissement

Des vignettes d'avertissement sont apposées pour qu'il soit facile de repérer les zones dangereuses. La signification des vignettes est donnée ci-dessous. Respecter les avertissements. Ne jamais retirer les vignettes et ne pas les laisser s'encrasser.

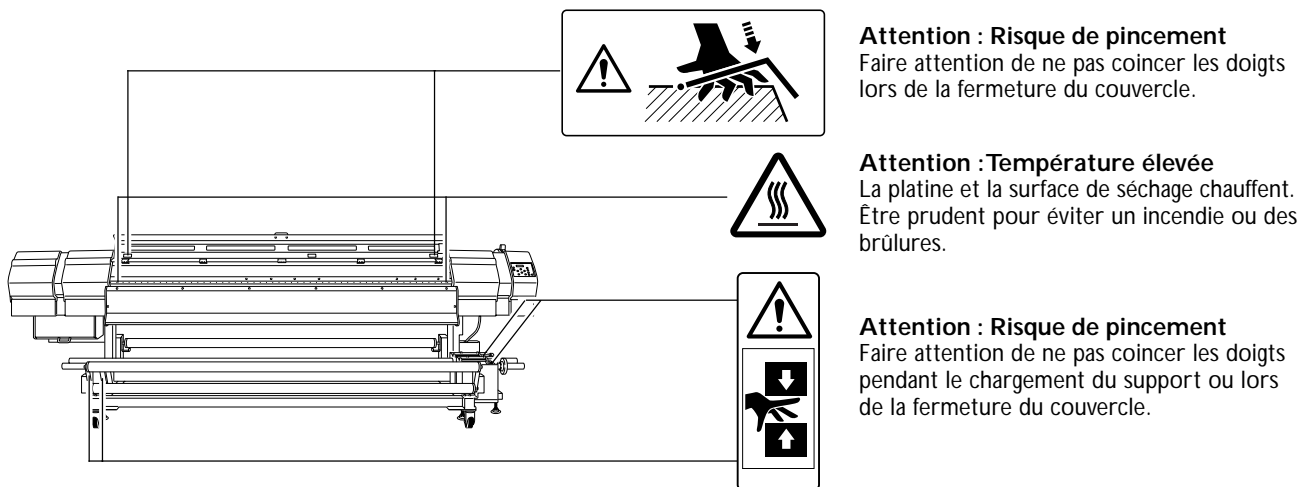
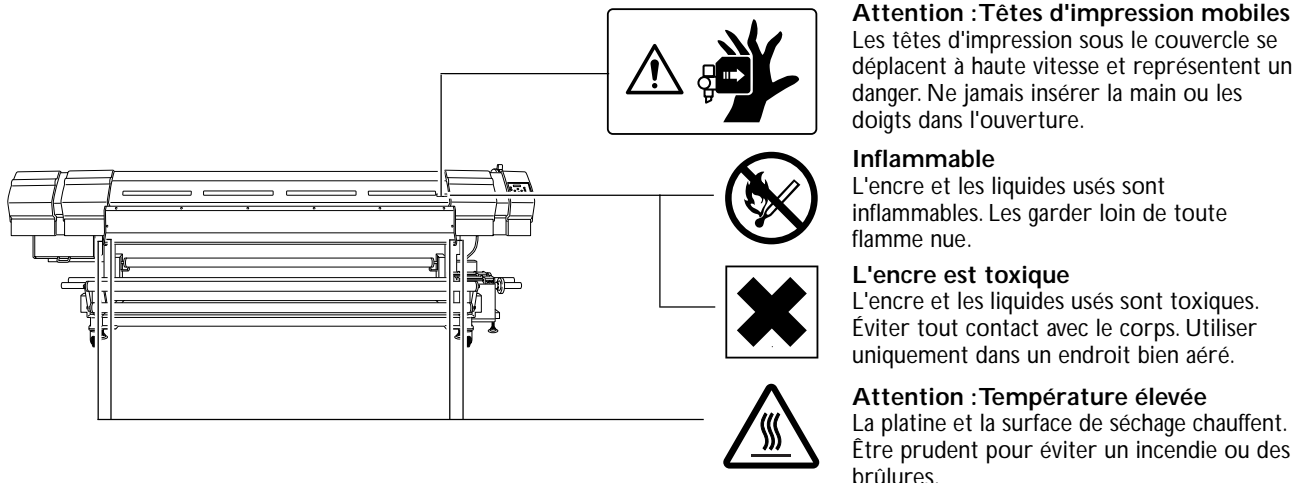

Inflammable

L'encre et les liquides usés sont inflammables. Les garder loin de toute flamme nue.



L'encre est toxique

L'encre et les liquides usés sont toxiques. Éviter tout contact avec le corps. Utiliser uniquement dans un endroit bien aéré.

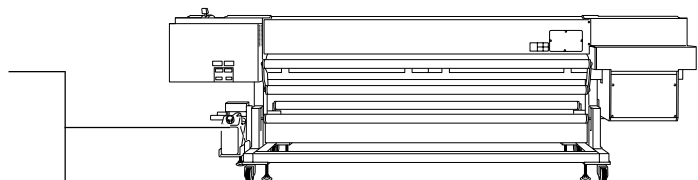

Setup Guide

1. Installation

Emplacement and Installation Operations

Emplacement and installation of the machine are to be carried out by a service technician.

⚠ WARNING Entrust operations such as transportation, unloading, and emplacement to trained workers.

Handling requires special equipment and training. Performing operations in an unreasonable manner may result in a major accident.

⚠ WARNING Be sure to secure the stand in place using the adjuster. Never loosen the adjuster. If the machine should begin to topple, a major accident may result, including crushing of the appendages or the body.

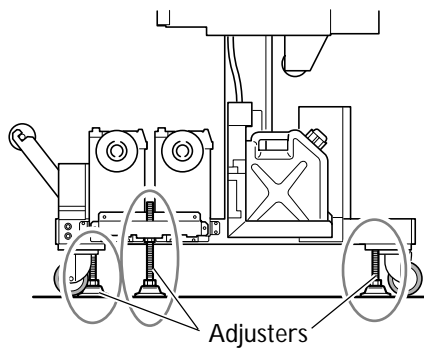

Deciding On an Installation Site

Install in a quiet, stable location offering good operating conditions. An unsuitable location can cause accident, fire, faulty operation, or breakdown.

⚠️ WARNING **Entrust operations such as transportation, unloading, and emplacement to trained the machine.**

The total weight of the machine may reach 700 kg (1550 lb.) or more. Installation in an unsuitable location may cause a major accident, including tipover, fall, or collapse.

⚠️ WARNING **Never install out of doors or in any location where exposure to water or high humidity may occur.**

Current leakage may cause electrical shock, electrocution, or combustion and fire.

⚠️ WARNING **Never install close to any flammable object or in a gas-filled location.**

Combustion or explosion may be a danger.

⚠️ WARNING **Install in a clean, brightly lit location.**

Working in a location that is dark or cluttered can be hazardous. Operations in such locations may cause an accident, such as tripping and becoming pinned under the roll media.

⚠️ CAUTION **Ensure adequate ventilation for the work area.**

Failing to perform ventilation may result in a health hazard or danger of combustion due to ink fumes.

⚠️ WARNING **Position so that the power plug is within immediate reach at all times.**

This is to enable quick disconnection of the power plug in the event of an emergency. Install the machine next to an electrical outlet. Also, provide enough empty space to allow immediate access to the electrical outlet.

Unsuitable Installation Sites

- Locations subject to large fluctuations in temperature or humidity
- Locations subject to shaking or vibration
- Locations where the floor is tilted, not level, or unstable
- Dusty locations
- Locations exposed to direct sunlight or near air-conditioning or heating equipment
- Locations exposed to water or moving air
- Locations exposed to considerable electrical or magnetic noise, or other forms of electromagnetic energy

1. Installation

Temperature and Humidity

Maintain the specified temperature and humidity even when the machine is not in use. Temperatures that are too high may degrade the ink and cause malfunction. Temperatures that are too low may cause the ink to freeze and damage the heads.

During operation: Temperature 20 to 32°C (68 to 89.6°F), relative humidity 35 to 80% (no condensation)

During nonoperation: Temperature 5 to 40°C (41 to 104°F), relative humidity 20 to 80% (no condensation)

Power Supply

This machine requires two 200 to 240 V commercial power outlets (having an amperage of 10 A or more). One outlet is for the main unit and the feed and take-up units, and the other is for the dryer. Be sure to use separate power-outlet systems.

Installation Space

The space shown in the figure is required in order to use this machine.

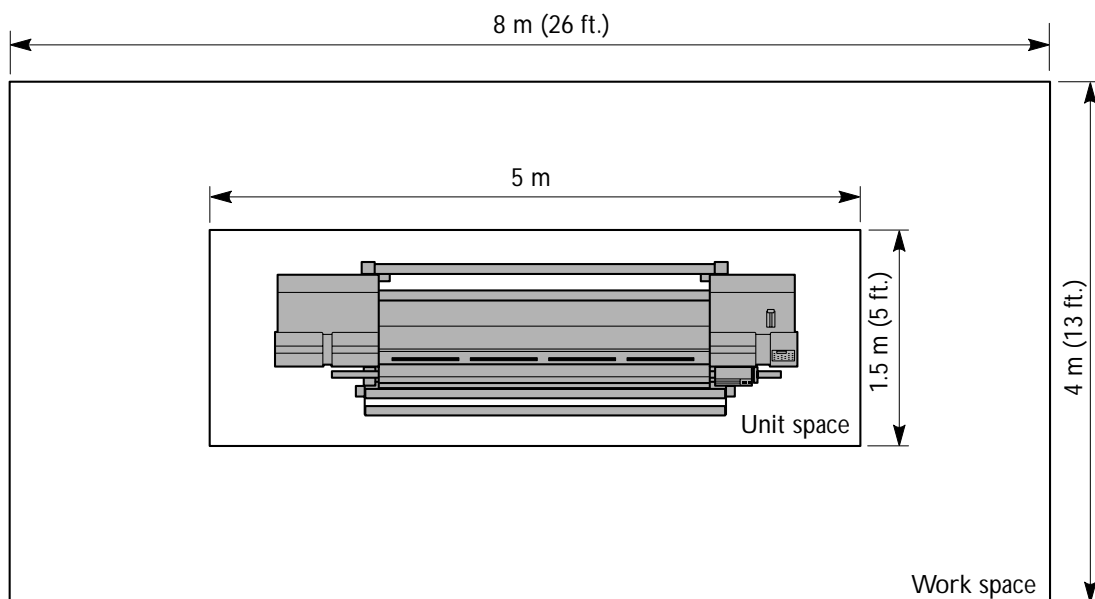

2. Included Items

The following items are included with the machine. Make sure they are all present and accounted for.

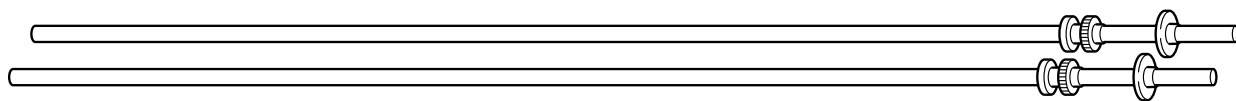

Roll shafts

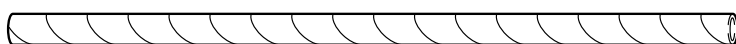

Paper pipe

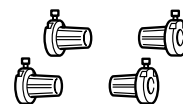

End caps

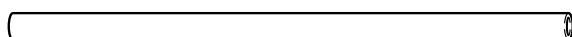

Media reinforcement pipe



Spacers

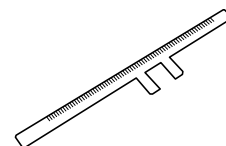

Media gauge

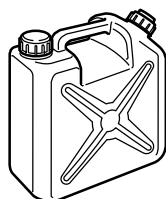

Drain bottle(*1)

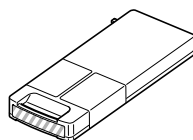

Maintenance liquid cartridge

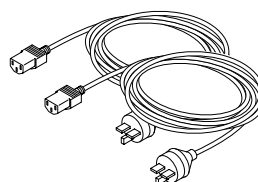

Power cords

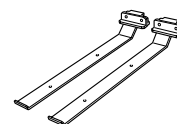

Media clamps

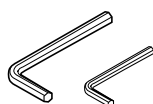

Hexagonal wrenches
(large, small) (*2)



Head-unit tool

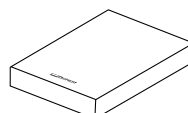

Software RIP set



Roland-PrintServer CD-ROM

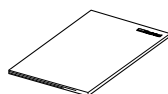

User's Manual

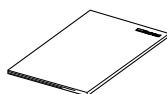

Setup Guide
(this document)

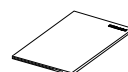

Roland-PrintServer
Network Setup Guide

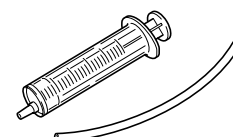

Syringe
Tube

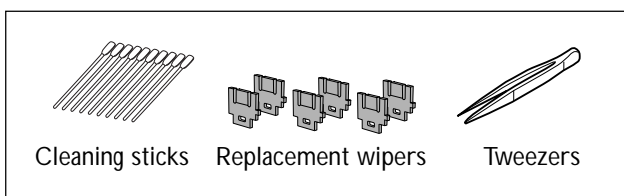

Cleaning sticks

Replacement wipers

Tweezers

Cleaning kit

*1 The drain bottle is installed on the machine.

*2 The small hexagonal wrench is used for installation and for relocation.

3. Removing the Packing Materials

Tape and packing materials are attached to the machine to protect it from vibration during transportation. When installation is complete, remove these.

CAUTION Perform this task with all power switches left switched off. Otherwise sudden movement of the machine may cause injury.

- > Remove all packing materials. Any that remain may cause faulty operation or breakdown when the power is switched on.
- > Store the packing materials carefully, because they are needed again when transporting the machine for relocation or the like.

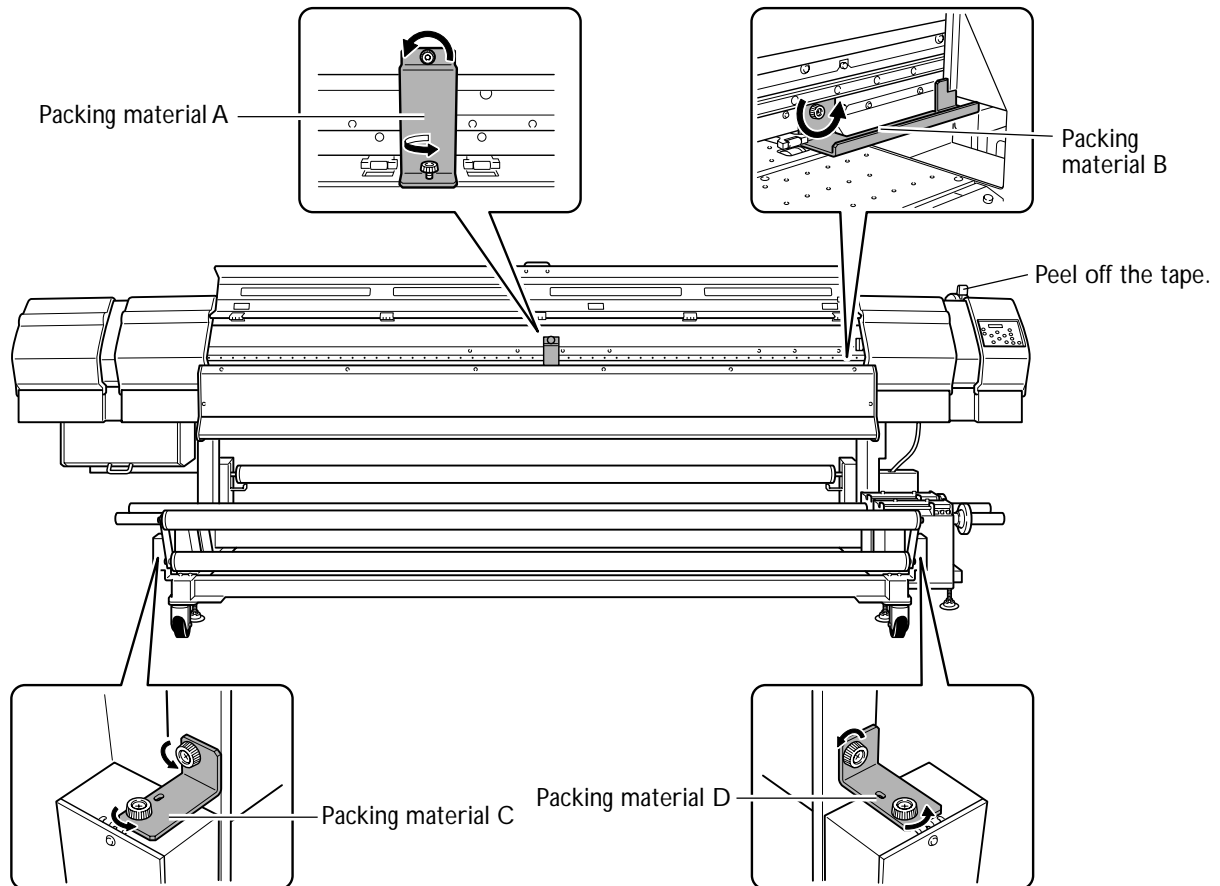

3. Removing the Packing Materials

You can attach the removed packing materials at the location shown in the figure for storage.

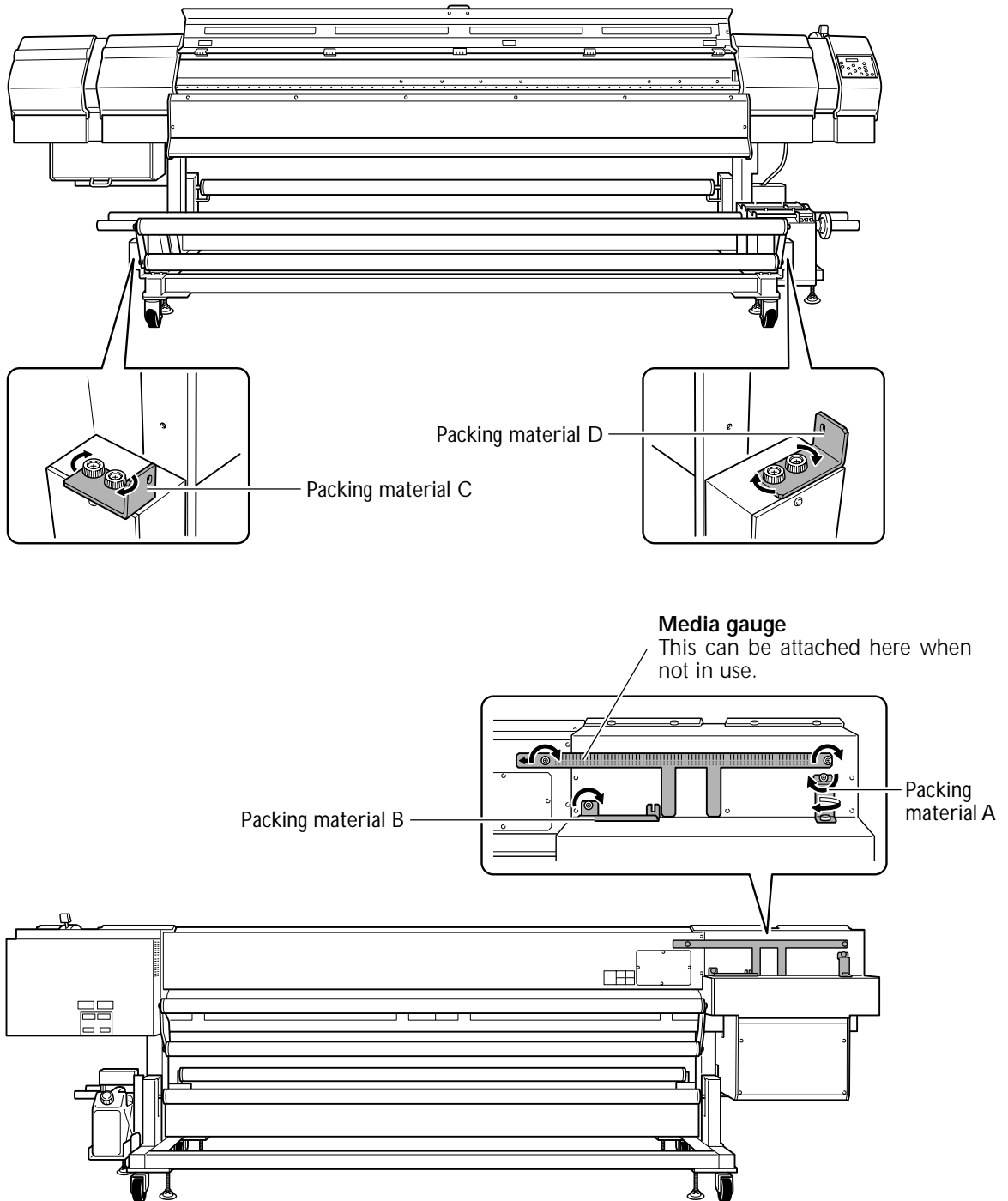

4. Connecting the Cables

Connecting the Cables

- ⚠ WARNING** Connect to an electrical outlet that complies with this machine's ratings (for voltage, frequency, and current).
Incorrect voltage or insufficient current may cause fire or electrical shock.
- ⚠ WARNING** Connect to ground.
This can prevent fire or electrical shock due to current leakage in the event of malfunction.
- ⚠ CAUTION** Perform this task with all power switches left switched off.
Otherwise sudden movement of the machine may cause injury.

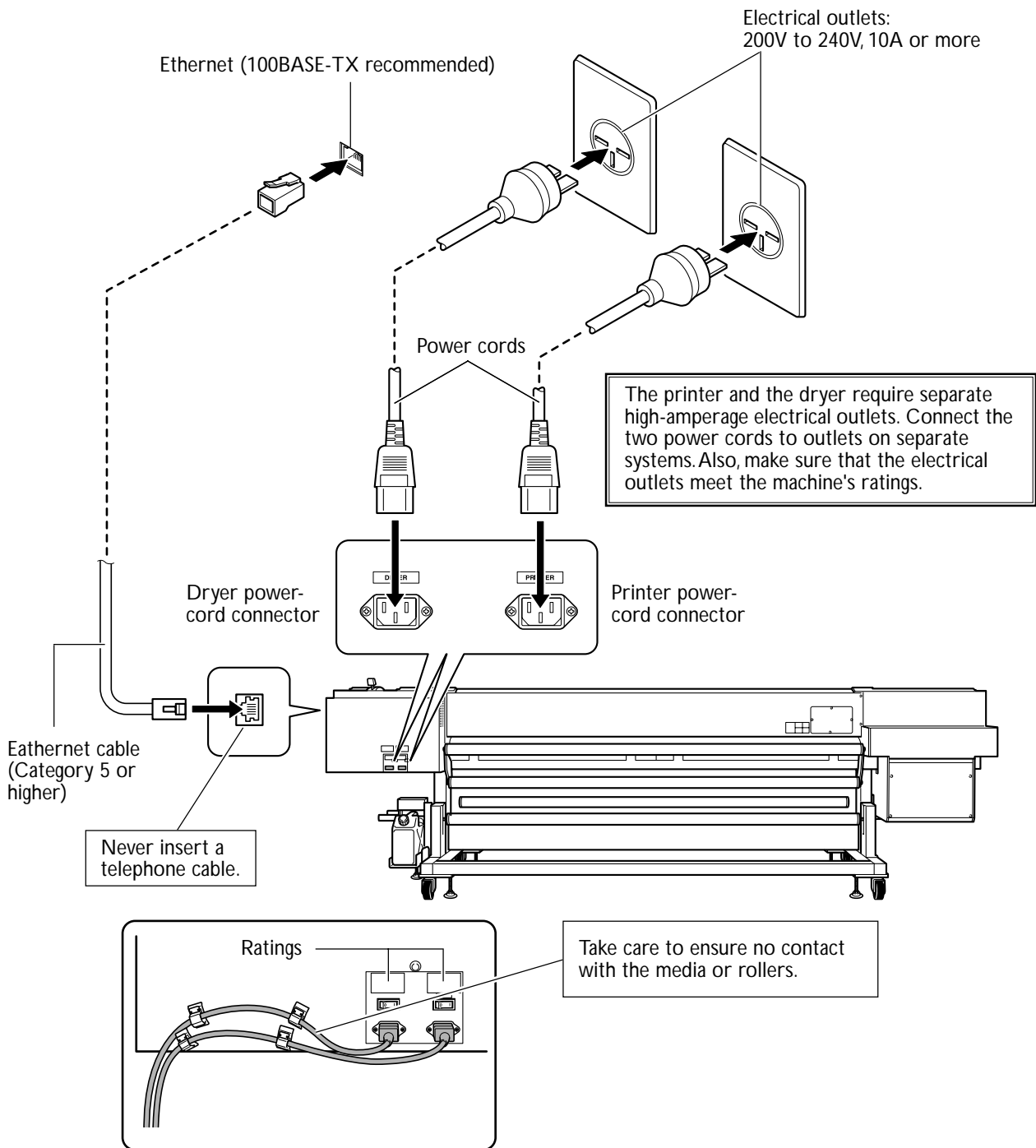

5. Installing the Ink Cartridges

Filling with Ink for the First Time

Special procedures are required when installing ink cartridges for the first time. These are required only once, when installing ink cartridges for the first time after shipment from the factory.

First load the maintenance liquid cartridge, then fill with the inks of each color.

Never under any circumstances use anything other than the specified type of ink or maintenance liquid.

1. Switch on the power and make the initial settings.

1

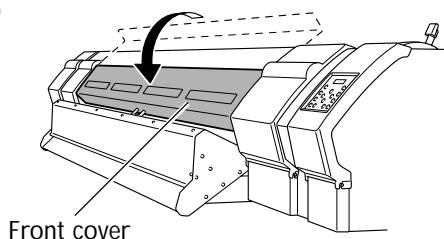

Close the front cover.

2

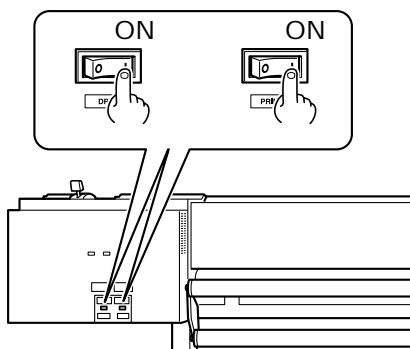

Switch on the main power switches.

3

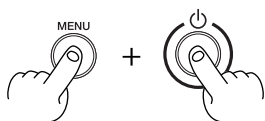

Hold down **MENU** and press the sub power switch.

4

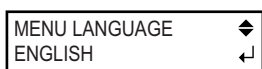

Use **▲** **▼** to select the language you want.
Press **ENTER**.

5



Use **▲** **▼** to select the unit of measurement you want (for length).
Press **ENTER**.

6



Use **▲** **▼** to select the unit of measurement you want (for temperature).
Press **ENTER**.

7

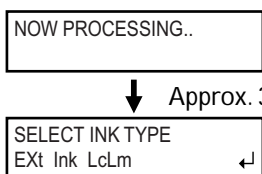

Wait for a screen like the one shown in the figure to appear.

2. Remove the cover, then remove the film that protects the heads from drying out.



Make sure the ink type matches the ink cartridges.
Press **ENTER**.

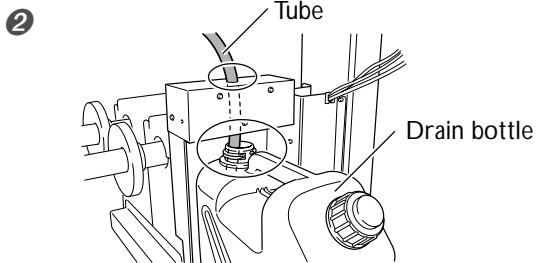

Make sure the drain bottle is installed.
Make sure the tube is inserted into the drain bottle.

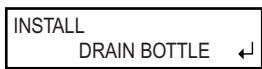

Press **ENTER**.

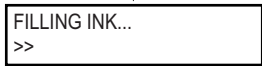

The display changes to show a screen like the one shown in the figure.



Preparations are complete when this screen appears.

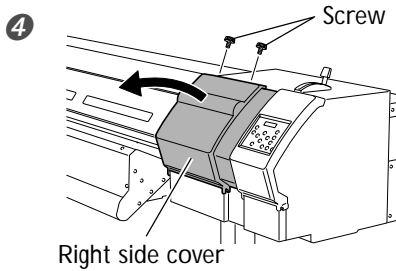

Remove the right side cover.

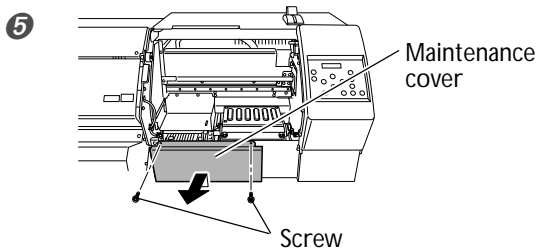

Remove the maintenance cover.

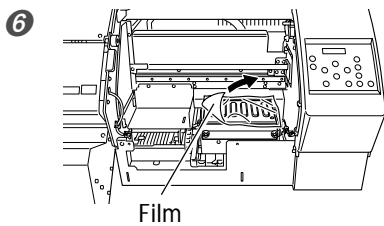

Remove the film.
Press **ENTER**.



Preparations are complete when this screen appears.

3. Load the maintenance liquid cartridge, then attach the cover.

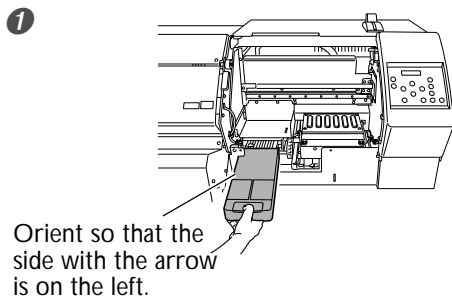

CLOSE RIGHT SIDE COVER

Load the maintenance liquid cartridge, then attach the cover.
 Insert firmly until you hear a beep.
 When it is inserted correctly, the screen shown in the figure appears.

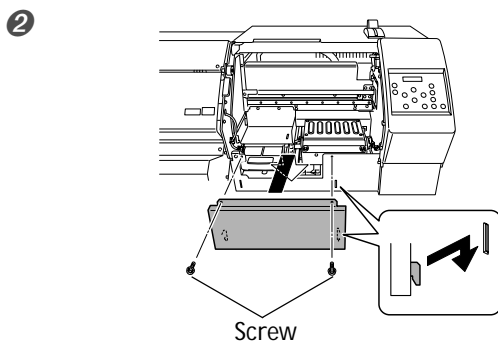

Attach the maintenance cover.

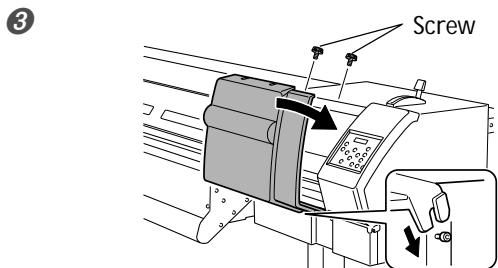

Attach the right side cover.

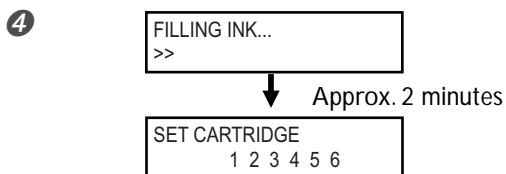

Wait for filling with maintenance liquid to finish.
 When filling finishes, the display changes to show a screen like the one shown in the figure.

4. Insert the ink cartridges for the respective colors.

1

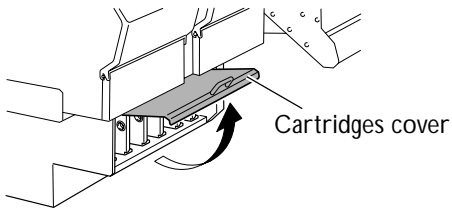

Open the cartridge cover.

2

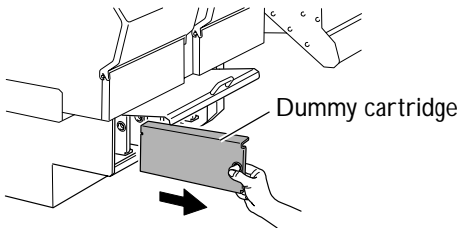

Remove the dummy cartridge.

Keep the removed dummy cartridge from being discarded. It is needed when the machine is moved.

3

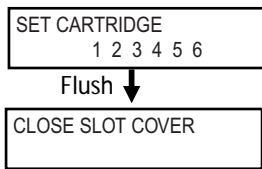

Insert the ink cartridge for each color.

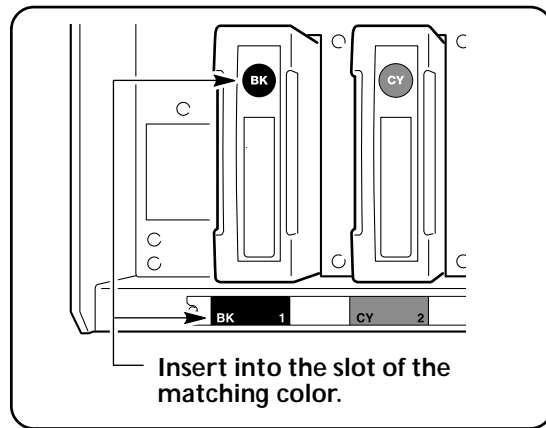
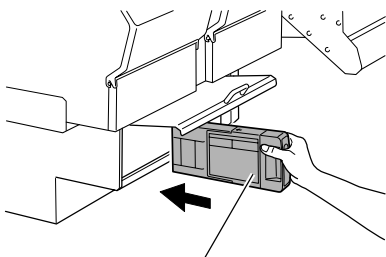

- > Keep the labeled side face up.
- > Insert and remove slowly, one at a time.
- > Be sure to insert firmly all the way, until you hear a beep.

4

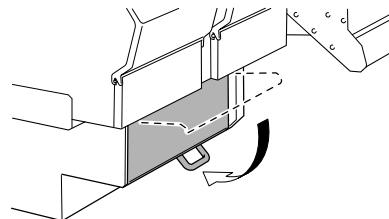

Close the cartridge cover.

Ink-filling is performed automatically.

Ink-filling takes about 15 minutes.

Never switch off the sub power while it is in progress.

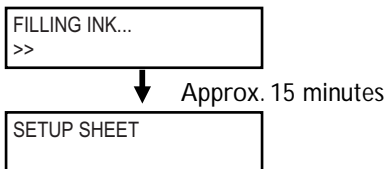

Ink-filling is completed.



100000947

R1-051228