

VS-640

64" Printer/Cutter

16/Feb/2010

Roland DGA Corporation

Imagine.  Roland®

High Image Quality

New Print Head

Metallic Silver Ink Option

Low Running Cost

64" Print/Cut Solution

User-friendly Design

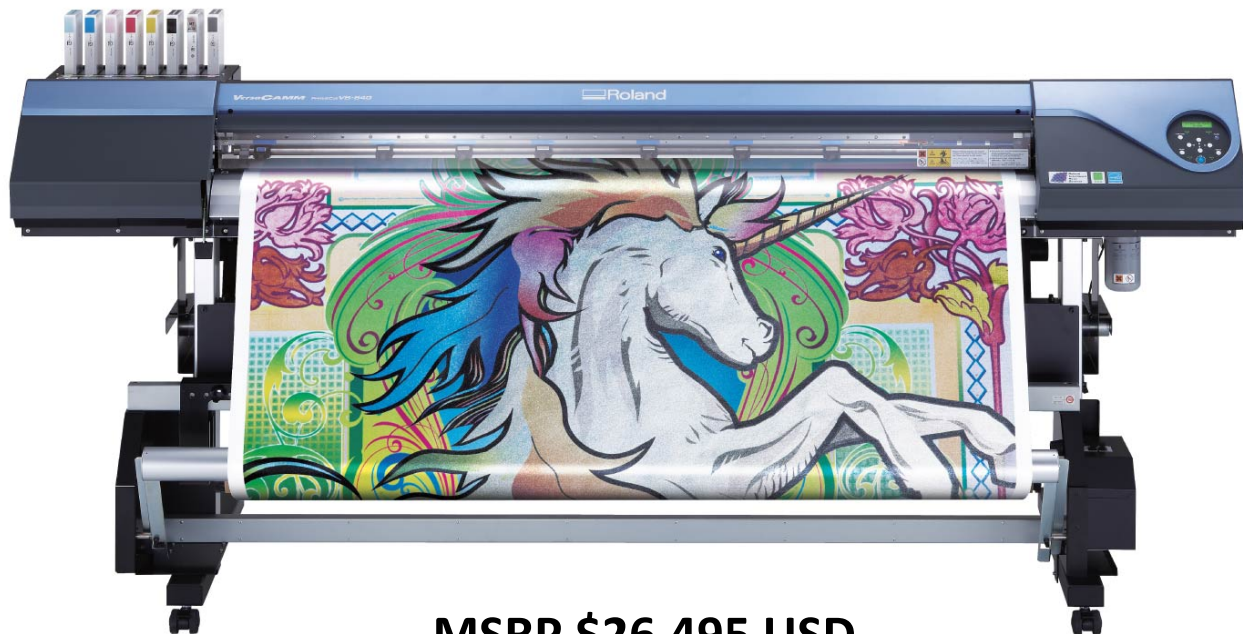

MSRP \$26,495 USD



MAX
ECO-501

**Print
& Cut**



RIP & PRINT MANAGEMENT SOFTWARE
Roland VersaWorks®

VersaCAMM **Print & Cut VS-640**

Imagine.  **Roland®**

Main Specification

Vertical ink cartridges
4 colors: CMYK (dual)
6 colors: CMYKLcLmCM
8 colors: CMYKLcLmWMT

VP-i/SP-i type pinch roller

New print head cut carriage

Ink circulation system
Reduce White/Metallic
Silver ink waste

Control panel & menu
Same as
VP-i/SP-i/RS

Lever
VP-i/SP-i/RS type lever

Print Heater/Dryer
Same as VP-i/SP-i/RS

TUC2-64 (Optional)
Same as VP-i/SP-i/RS

Heavy duty feed system
88 lbs media roll capacity

VersaCAMM Print & Cut **VS-640**



High Image Quality

Improved variable dot control produces exceptional image quality

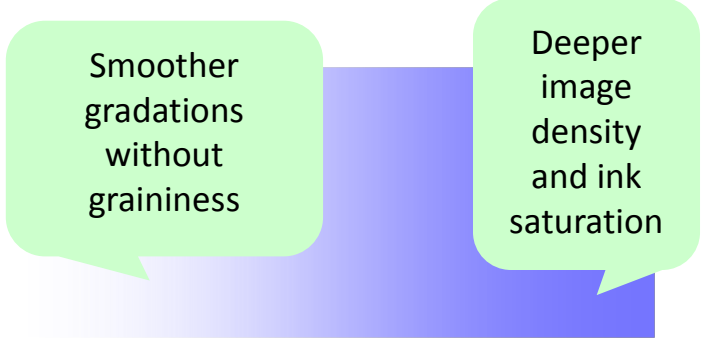
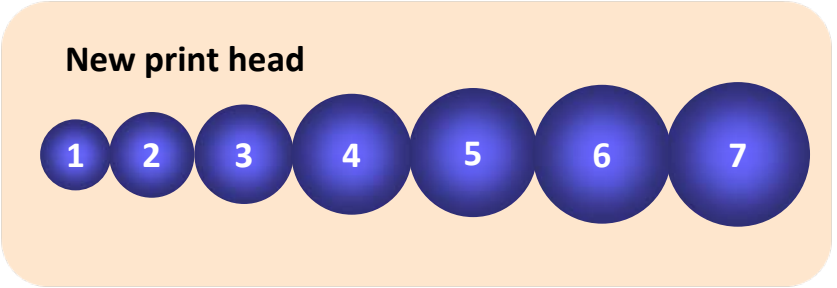
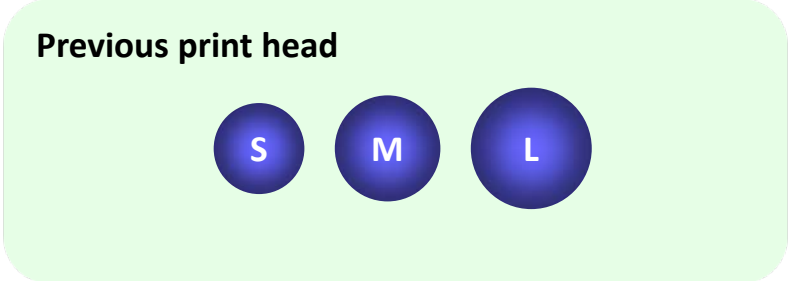

Mix the best 3 out of 7 dot sizes depending on resolution & print mode for enhanced image quality, smoother gradients and improved ink saturation



Dual CMYK Ink Configuration

Mirrored color configuration increases throughput while minimizing chromatic banding

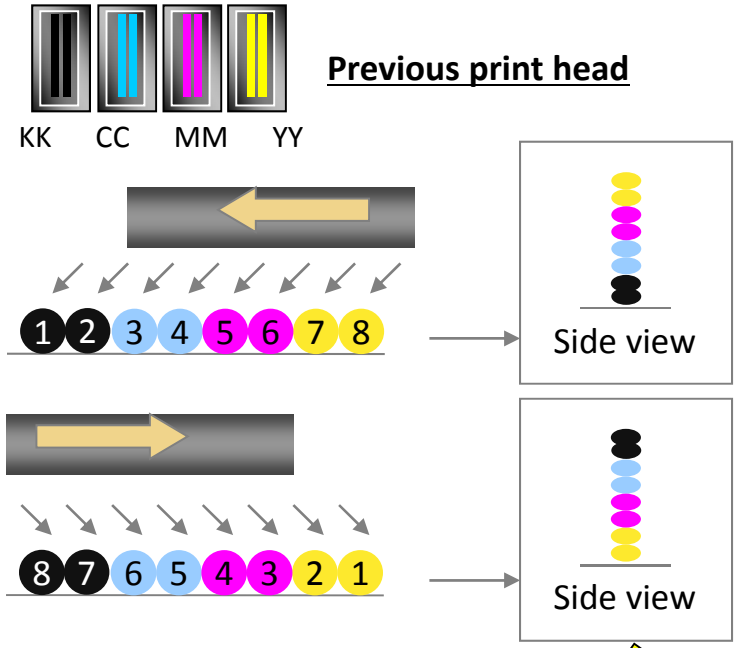

Different firing order can cause chromatic banding during bi-directional printing

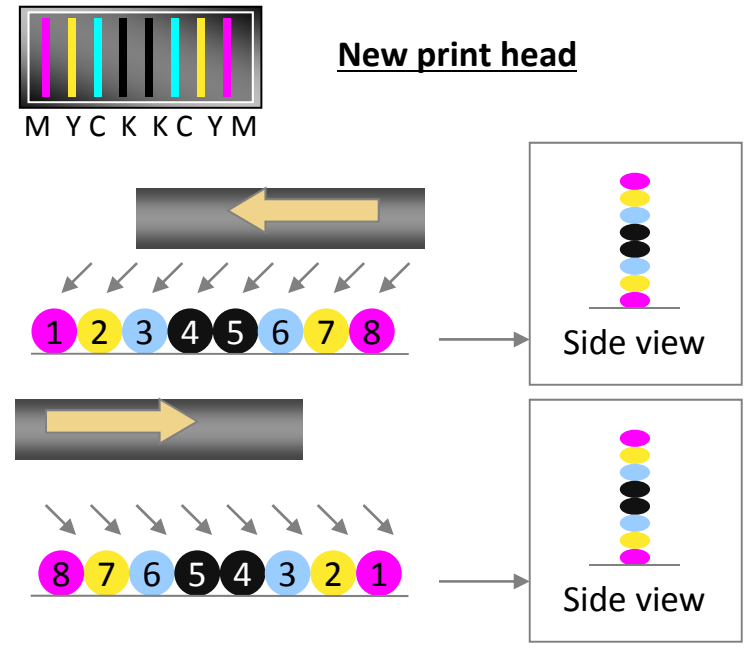

No difference in ink firing order between uni-directional and bi-directional printing



Roland Metallic Color Library

A new Roland Metallic Color library in VersaWorks 4.0 features **512 metallic colors** that print CMYK+MT in a single pass. Users can also easily create and save their own custom metallic spot colors in VersaWorks.

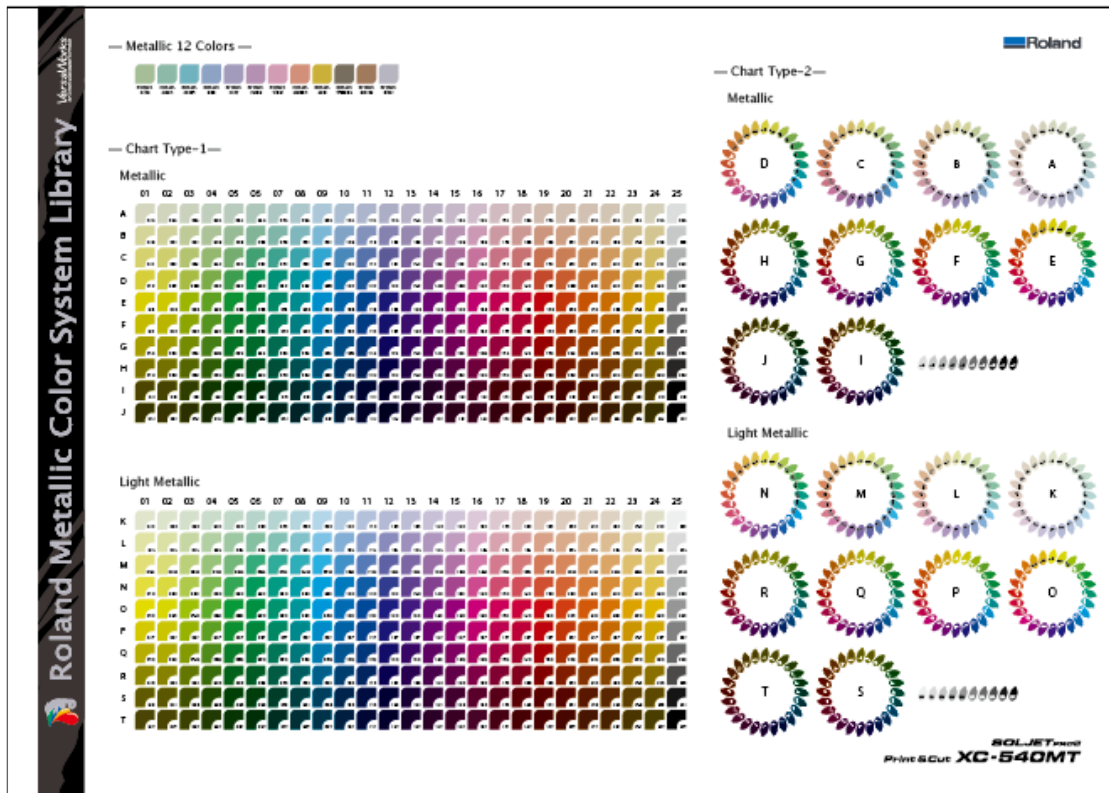

Imagine.  Roland[®]

Unattended Print-Cut using Takeup

Using optional TU2 Takeup system

- ❖ Uses CustomCUT feature in VersaWorks
 - Select height of 12" (300mm) to avoid print touching floor
 - Assign "TU2 Mode" on control panel for unattended operation
 - \$2094.75 plugs into rear of the machine and automatically connects

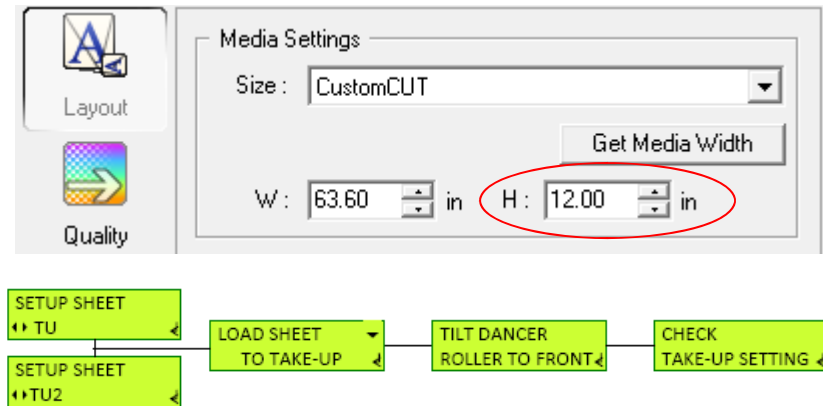
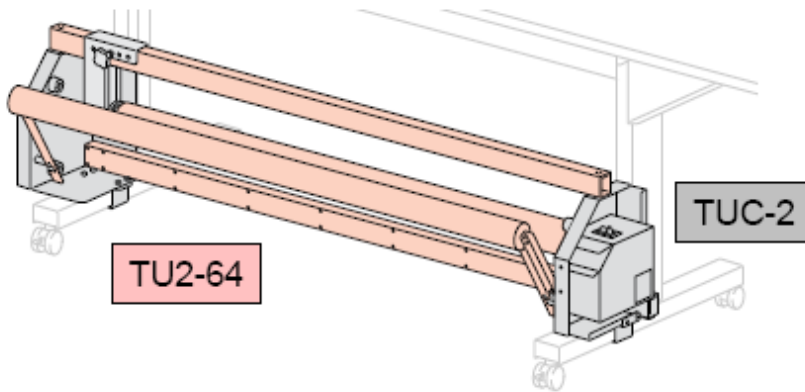

Low Running Cost

Unique ink circulation system minimizes ink waste

❖ Reduces cost

- Prevents the heavy pigment in metallic and white inks from settling and re-circulates instead of discharging.
- Cycles every 12 hours, without discharging an ink

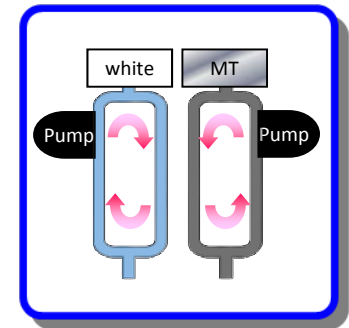

❖ Stable printing performance

- Cycles ink automatically without user intervention
- 2 pumps control re-circulation of White and Metallic Silver

*Same recirculation system as LEC-330/XC-540MT

Roland OnSupport

Online user portal connecting directly to Roland



❖ Device updates and info

- Download latest firmware, users manuals, how-to guides for the VS-640
- Device name, serial number and ink type

❖ Productivity

- Receive email updates and machine usage info
 - Number and frequency of cleaning cycles
 - Motor operating time
 - Ink consumption

64" Print & Cut Width

❖ Providing diversified applications from decals and t-shirts to seamless vehicle wraps

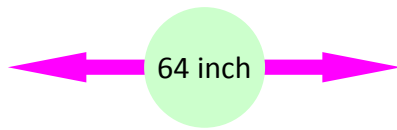

Vehicle wrapping



Package prototype

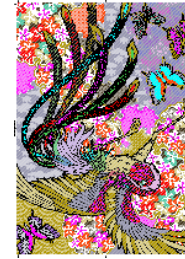

Fine art



POP



Banners



Garment decoration



Label/sticker

Selectable Ink Configurations

Ink configuration must be selected upon installation.
It cannot be changed once selected.



MYCKKCYM



4 colors (MYCKKCYM)



MCMYKLmLcC



6 colors (MCMYKLmLcC)



WCMYKLmLcMt



8 colors (WCMYKLmLcMt)*

*Versaworks can drive 6 colors (CMYKLcLm) and 1 special color (White OR Metallic)

*Versaworks can drive 4 colors (CMYK) and 2 special colors (White AND Metallic)

High Productivity

4 Color	Vinyl	Banner
Billboard	N/A	248.6 sq ft/hr (23.1 sq m)
High Speed	141 sq ft/hr (13.1 sq m)	190.5 sq ft/hr (17.7 sq m)
Standard	117 sq ft/hr (10.9 sq m)	141 sq ft/hr (13.1 sq m)
High Quality	51.6 sq ft/hr (4.8 sq m)	58 sq ft/hr (5.4 sq m)
6/8 Color	Vinyl	Banner
High Speed	68.9 sq ft/hr (6.4 sq m)	95.8 sq ft/hr (8.9 sq m)
Standard	58 sq ft/hr (5.4 sq m)	68.9 sq ft/hr (6.4 sq m)
High Quality	N/A	24.7 sq ft/hr (2.3 sq m)
Metallic & White	(High Quality Only)	
CMYKLcLmMt	15 sq ft/hr (1.4 sq m)	
Metallic Silver	19 sq ft/hr (1.8 sq m)	
White -> CMYKMt	4 sq ft/hr (0.4 sq m)	
CMYKMt -> White	4 sq ft/hr (0.4 sq m)	
White	24.7 sq ft/hr (2.3 sq m)	

User Friendly Design

❖ Heavy duty media feed system

- Media flanges for easy loading of heavy rolls
- Able to support 64" media
- Supports rolls up to 88 pounds and 8.3" in diameter



❖ Vertical cartridge configuration

- Able to replace ink from front or back of device
- Space-saving design



❖ New wiper system

- Passive wiper system using natural motion of the print carriage to clean print head surface
- Reduces the need for manual cleaning of the print head by the user
- User replaceable wiper blades and easy to clean wiper scraper

Roland Support

❖ Roland Care

- Preventive maintenance plans
- Extended warranties



❖ 2 Year Warranty

- Warranty extended to 2 years based on ECO-SOL MAX inks and product registration



Thank you

Imagine.  Roland®