

CAMM-3

Modeling Machine by Roland DG Corporation

PNC-3200

USER'S MANUAL

1

Setup & Maintenance

Thank you very much for purchasing the PNC-3200.

- To ensure correct and safe usage with a full understanding of this product's performance, please be sure to read through this manual completely and store it in a safe location.
- Unauthorized copying or transferral, in whole or in part, of this manual is prohibited.
- The contents of this operation manual and the specifications of this product are subject to change without notice.
- The operation manual and the product have been prepared and tested as much as possible. If you find any misprint or error, please inform us.

For the USA

**FEDERAL COMMUNICATIONS COMMISSION
RADIO FREQUENCY INTERFERENCE
STATEMENT**

This equipment has been tested and found to comply with the limits for a Class A digital device, pursuant to Part 15 of the FCC Rules.

These limits are designed to provide reasonable protection against harmful interference when the equipment is operated in a commercial environment.

This equipment generates, uses, and can radiate radio frequency energy and, if not installed and used in accordance with the instruction manual, may cause harmful interference to radio communications.

Operation of this equipment in a residential area is likely to cause harmful interference in which case the user will be required to correct the interference at his own expense.

Unauthorized changes or modification to this system can void the users authority to operate this equipment.

The I/O cables between this equipment and the computing device must be shielded.

For Canada

CLASS A NOTICE

This Class A digital apparatus meets all requirements of the Canadian Interference-Causing Equipment Regulations.

CLASSE A AVIS

Cet appareil numérique de la classe A respecte toutes les exigences du Règlement sur le matériel brouilleur du Canada.

WARNING

This is a Class A product. In a domestic environment this product may cause radio interference in which case the user may be required to take adequate measures.

Table of Contents

To Ensure Safe Use	2
About the Labels Affixed to the Unit	3
How The Manuals Are Organized	9
1 Checking the Accessories	10
2 Name of Parts	11
Front	11
Right side	11
3 Setting Up and Connection	12
Setting Up	12
Connection	13
4 Installing the Software	15
Using with Windows	15
Using with Macintosh	18
5 Selection of the Command Set	20
Selecting the Command Set on the PNC-3200	20
6 Setting the Connection Parameters	21
If You've Selected RML-1	21
If You've Selected NC codes	22
7 Loading a Workpiece for Cutting	23
8 Cutting Tool Attachment	24
Maintenance	26
Cleaning the Main Unit	26
Cleaning After Operation	26
Checking the Spindle Motor	27
Display of Spindle Rotation Time	27
Recommended Service Checking	28
Specifications	29

Windows®, Windows NT® and MS-DOS are registered trademarks or trademarks of Microsoft® Corporation in the United States and/or other countries.



Mac OS, Macintosh, Power Macintosh, Power Book, and Apple logo are registered trademarks or trademarks of Apple Computer, Inc. in the USA and other countries.

i486 and Pentium are registered trademarks of Intel Corporation in the United States.



IBM is a registered trademark of International Business Machines Corporation.

To Ensure Safe Use

About ⚠ WARNING and ⚠ CAUTION Notices

 WARNING	Used for instructions intended to alert the user to the risk of death or severe injury should the unit be used improperly.
 CAUTION	Used for instructions intended to alert the user to the risk of injury or material damage should the unit be used improperly. * Material damage refers to damage or other adverse effects caused with respect to the home and all its furnishings, as well to domestic animals or pets.

About the Symbols

	The ⚠ symbol alerts the user to important instructions or warnings. The specific meaning of the symbol is determined by the design contained within the triangle. The symbol at left means "danger of electrocution."
	The ⚡ symbol alerts the user to items that must never be carried out (are forbidden). The specific thing that must not be done is indicated by the design contained within the circle. The symbol at left means the unit must never be disassembled.
	The ● symbol alerts the user to things that must be carried out. The specific thing that must be done is indicated by the design contained within the circle. The symbol at left means the power-cord plug must be unplugged from the outlet.

⚠ WARNING



Do not disassemble, repair, or modify.

Doing so may lead to fire or abnormal operation resulting in injury.



Do not use with any electrical power supply that does not meet the ratings displayed on the unit.

Use with any other power supply may lead to fire or electrocution.



Ground the unit with the ground wire.

Failure to do so may result in risk of electrical shock in the even of a mechanical problem



Do not use while in an abnormal state (i.e., emitting smoke, burning odor, unusual noise, or the like).

Doing so may result in fire or electrical shock.

Immediately switch off the power, unplug the power cord from the electrical outlet, and contact your authorized Roland DG Corp. dealer or service center.

CAUTION



Do not use with a damaged power cord or plug, or with a loose electrical outlet.

Use with any other power supply may lead to fire or electrocution.

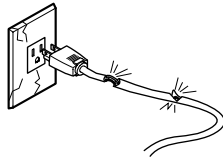

When not in use for extended periods, unplug the power cord from the electrical outlet.

Failure to do so may result in danger of shock, electrocution, or fire due to deterioration of the electrical insulation.

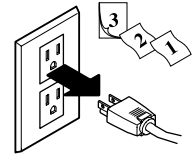

Do not injure or modify the electrical power cord, nor subject it to excessive bends, twists, pulls, binding, or pinching, nor place any object of weight on it.

Doing so may damage the electrical power cord, leading to electrocution or fire.

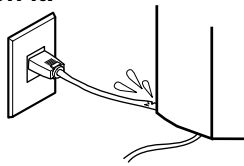

When unplugging the electrical power cord from the power outlet, grasp the plug, not the cord.

Unplugging by pulling the cord may damage it, leading to fire or electrocution.

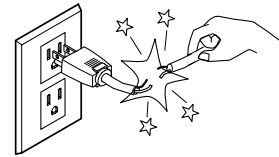

Do not attempt to unplug the power cord with wet hands.

Doing so may result in electrical shock.

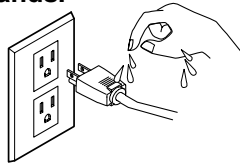

Install on a stable surface.

Failure to do so may result in falling of the unit, leading to injury.

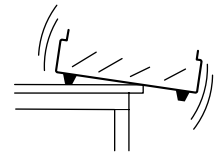

Unpacking, installation, and moving must be carried out by two or more persons.

Failure to do so may result in falling of the unit, leading to injury. (The machine weighs 60 kg (132.3 lb.).)

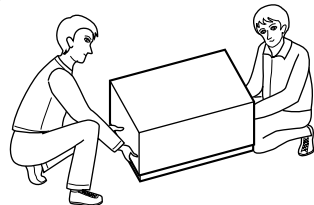

Moving the unit is an operation that must be carried out by two or more persons, grasping the grips at the front and rear of the unit.

If grasped by the rear cover, the unit may fall, resulting in injury.

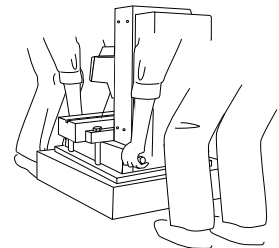

Do not place anything within the moving area of the XY table.

The object may bump into the XY table and fall, resulting in injury.

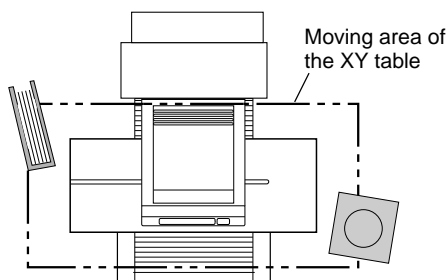

Do not block the ventilation holes.

Blocking the ventilation holes at the rear of the unit may prevent heat radiation and cause fire.

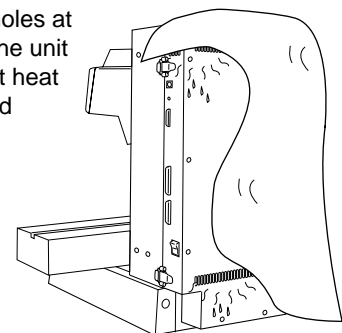

⚠ CAUTION



Do not place a load of 8 kg (17.6 lb.) or more (combined weight of the workpiece and vise) on the XY table.
The unit may tip over, resulting in injury.

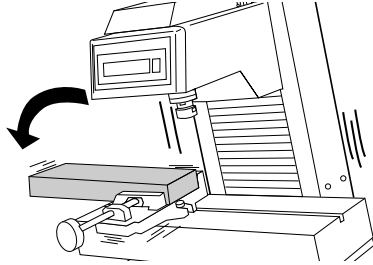

Fasten the tool and material securely in place.
Otherwise they may come loose during cutting, resulting in injury.

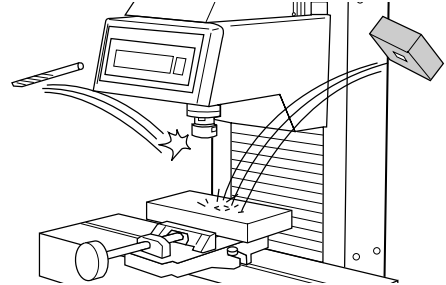

Do not touch the tip of the blade with your fingers.
Doing so may result in injury.



When mounting or removing a tool, first switch off the spindle switch.
Doing so may result in injury.

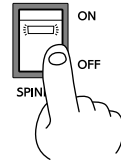

Perform dry cutting with no cutting oil.
Such materials can cause fire.

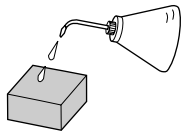

Wear dust goggles and mask during use.
Cutting dust may scatter, causing bodily injury.

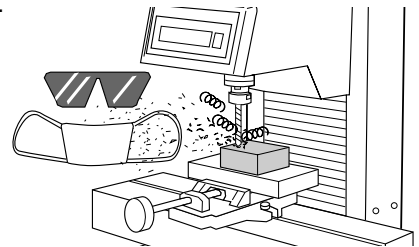

Do not wear gloves, a necktie or wide-sleeved clothing.
They may become caught in the tool, resulting in injury.

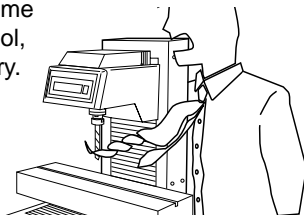

Do not insert the fingers between the XY table and base or between the head and Z cover.
The fingers may be pinched, resulting in injury.

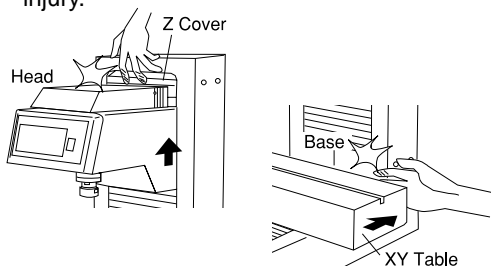

Do not insert the fingers between the XY table and base or between the head and Z cover.
Doing so may result in injury.

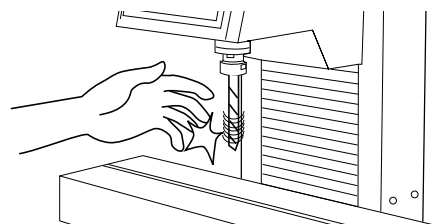

CAUTION



Do not operate beyond capacity or subject the tool to undue force.

The tool may break or fly off in a random direction. If cutting beyond capacity is mistakenly started, immediately turn off the spindle switch.



Do not touch the tool immediately after cutting operating stops.

The tool may have become hot due to friction heat and may cause burns if touched.



When cleaning, set the power switch on the unit to OFF.

Failure to do so may result in injury or electrical shock.



Please use a vacuum cleaner to remove cutting dust.

Do not use any blower like airbrush. Otherwise, dust spread in the air may harm your health.



When you're finished, wash your hands to rinse away all cuttings.



Do not allow liquids, metal objects or flammables inside the machine.

Such materials can cause fire.

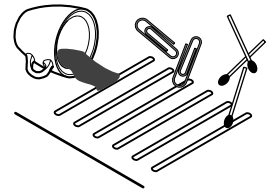

About the Labels Affixed to the Unit

These labels are affixed to the body of this product.
The following figure describes the location and content of these messages.

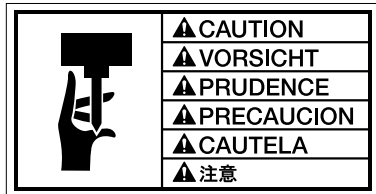

Handle tool with care.



Do not insert fingers between the head and Z cover during operation.

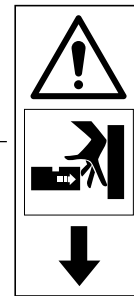
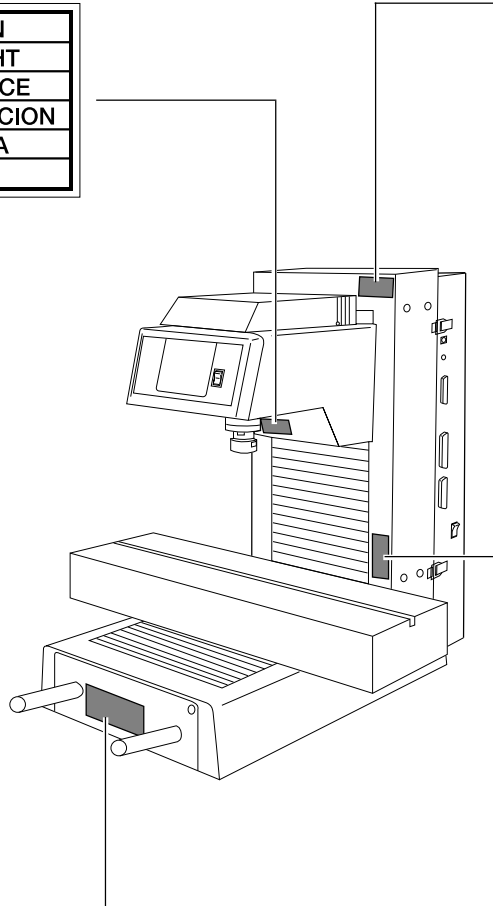

Do not insert fingers between XY table and base during operation.

	<p>▲ CAUTION Do not place anything within the moving area of the XY TABLE.</p>	<p>▲ PRECAUCION No situar ningún objeto dentro del area de movimiento de la mesa XY.</p>
	<p>▲ VORSICHT Legen Sie keine Gegenstände in den Arbeitsbereich des XY Tisches.</p>	<p>▲ CAUTELA Non porre oggetti nell'area di movimento della tavola XY.</p>
	<p>▲ PRUDENCE Ne jamais rien déposer dans la zone de travail de la table XY.</p>	<p>▲ 注意 XYテーブルの動作範囲内に物を置かないでください。</p>

Do not place anything within the moving area of the XY table.

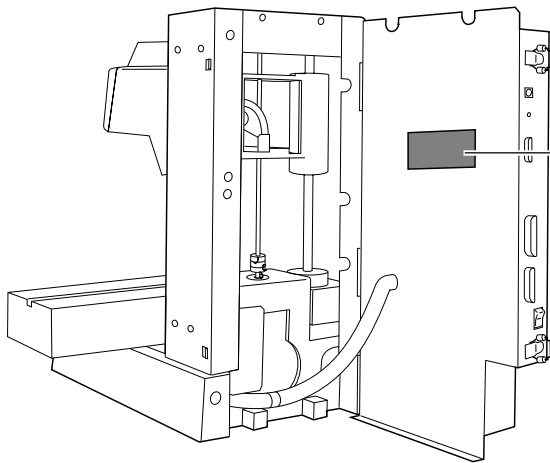

CAUTION
Do not touch the interior of the device directly with the hands.

VORSICHT
Nicht das Innere des Gerätes direkt mit den Händen berühren.

PRUDENCE
Ne pas toucher l'intérieur de l'appareil directement avec les mains.

PRECAUCION
No toque el interior del equipo directamente con las manos.

CAUTELA
Non toccare direttamente con le mani l'interno del dispositivo.

注意
機器内部は、直接、手で触れないでください。

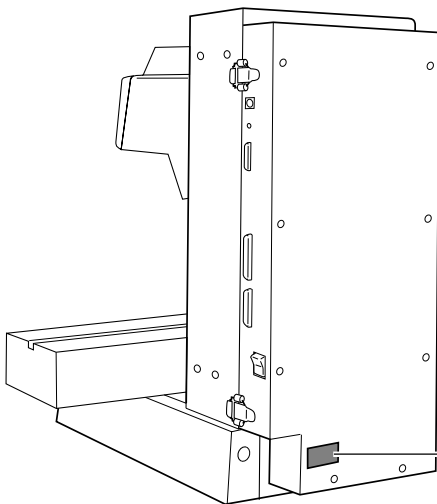

Model name
Rating label

Use a rated power supply.

In addition to the  **WARNING** and  **CAUTION** symbols, the symbols shown below are also used.

NOTICE : Indicates information to prevent machine breakdown or malfunction and ensure correct use.



: Indicates a handy tip or advice regarding use.

MEMO

How The Manuals Are Organized

The manuals for the PNC-3200 are organized as follows. Refer to the appropriate one according to the purpose at hand.

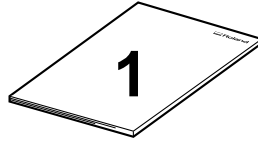

USER'S MANUAL 1 "Setup & Maintenance"

This describes installation, connection, preparations for starting cutting, and the care and maintenance of the machine.

When cutting
using RML-1

When cutting
using NC codes

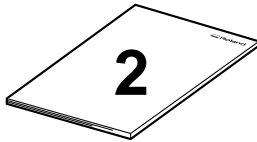

USER'S MANUAL 2 "Cutting Using RML-1"

This describes operation methods when using RML-1 to perform cutting.

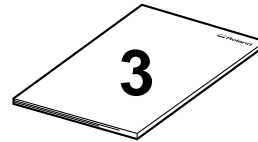

USER'S MANUAL 3 "Cutting Using NC Codes"

This describes operation methods when using NC codes to perform cutting.

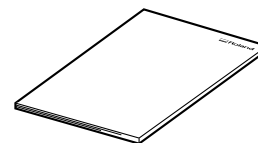

NC code PROGRAMMER'S MANUAL

This describes the NC codes supported by the PNC-3200. It explains the basics of programming as well as each code.

1 Checking the Accessories

The following items are packed together with the unit.



Collet cap

◀ These are installed on the unit. ▶

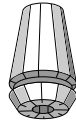

Collet chuck



Z0 position sensor

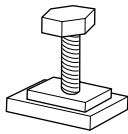

*T nuts : 2
(For installing the work attachment)

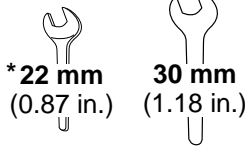

*22 mm (0.87 in.) 30 mm (1.18 in.)
Spanners
(For tool attachment)

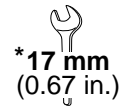

*17 mm (0.67 in.)
Spanner
(For removal of the securing board)

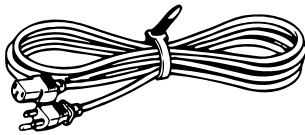

Power cord

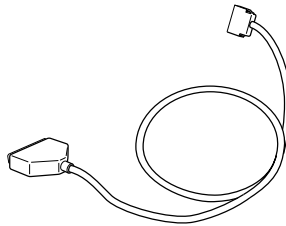

Cable
(For connecting the switch panel)

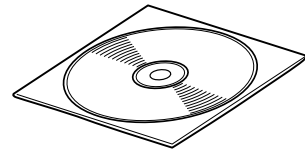

Roland Software Package
CD-ROM

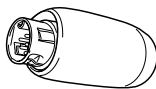

Key connector
(The machine does not run unless this is inserted.)

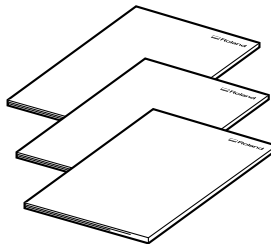

USER'S MANUAL
(1 Setup & Maintenance)
(2 Cutting Using RML-1)
(3 Cutting Using NC codes)

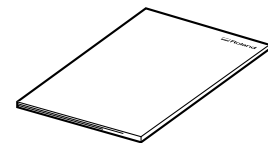

NC Code
PROGRAMMER'S MANUAL

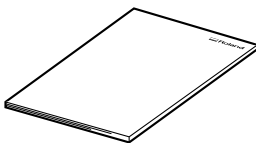

MODELA 3D DESIGN/
MODELA 3D TEXT/
MODELA Player
USER'S MANUAL

(In this documentation, please replace "MDX-3" with "PNC-3200" as you read.)

Items indicated by "*" are included in the bag of tools.

2 Names of Parts

Front

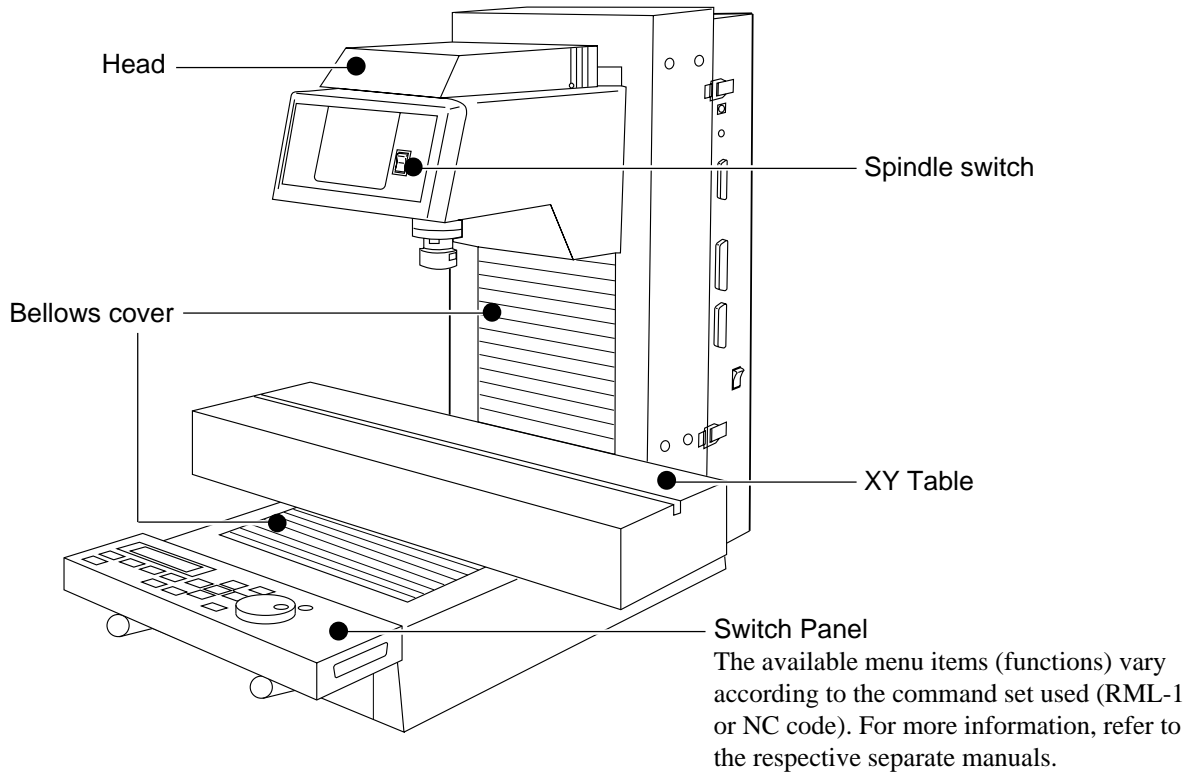

Right side

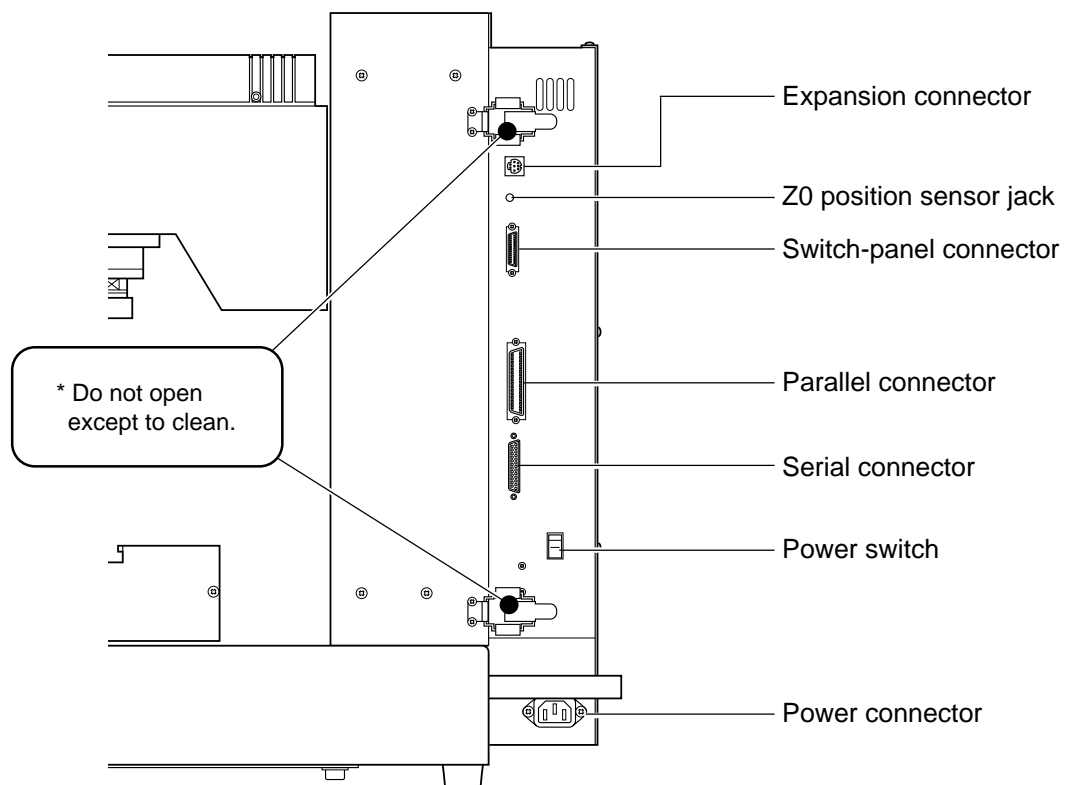

3 Setting Up and Connection

Setting Up

⚠ CAUTION



Install on a stable surface.

Failure to do so may result in falling of the unit, leading to injury.

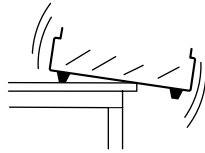

Do not place anything within the moving area of the XY table.

The object may bump into the XY table and fall, resulting in injury.

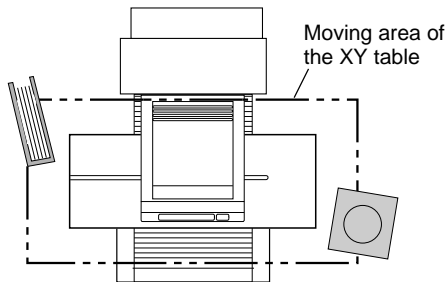

Moving the unit is an operation that must be carried out by two or more persons, grasping the grips at the front and rear of the unit.

If grasped by the rear cover, the unit may fall, resulting in injury.

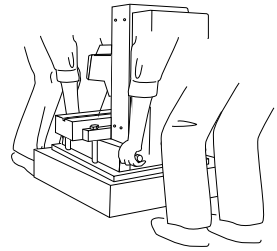

Unpacking, installation, and moving must be carried out by two or more persons.

Failure to do so may result in falling of the unit, leading to injury. (The machine weighs 60 kg (132.3 lb.).)

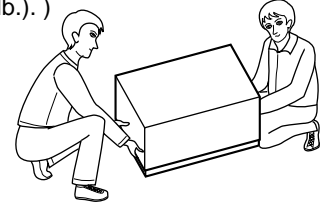

NOTICE

Use within a temperature range of 5 to 40°C (41 to 104°F) and within a humidity range of 35 to 80%.

Do not place any objects on the main unit's head or rear cover.

To prevent accidents, do not install in any of the following types of areas.

- Avoid use in areas subject to strong electric noise.
- Avoid use in areas subject to high humidity or dust.
- The PNC-3200 generates heat when used, and should not be installed in an area with poor heat radiation characteristics.
- Do not install in an area subject to strong vibration.

Installation of the PNC-3200 requires a minimum space measuring 800 mm (31-1/2 in.) high by 1,000 mm (39-3/8 in.) wide by 1,000 mm (39-3/8 in.) deep.

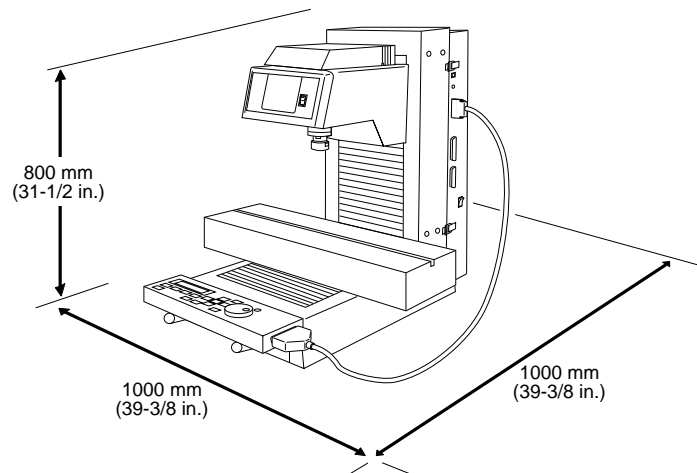

Connection

⚠ WARNING



Ground the unit with the ground wire.

Failure to do so may result in risk of electrical shock in the even of a mechanical problem



Do not use with any electrical power supply that does not meet the ratings displayed on the unit.

Use with any other power supply may lead to fire or electrocution.

NOTICE

Be sure that the power to both the computer and the main unit is switched off when connecting the cable.

The included cable (for connecting the switch panel) should not be used to connect any other devices. Doing so may damage the equipment.

Securely connect the power cord, computer I/O cable and so on so that they will not be unplugged and cause failure during operation. Doing so may lead to faulty operation or breakdown.

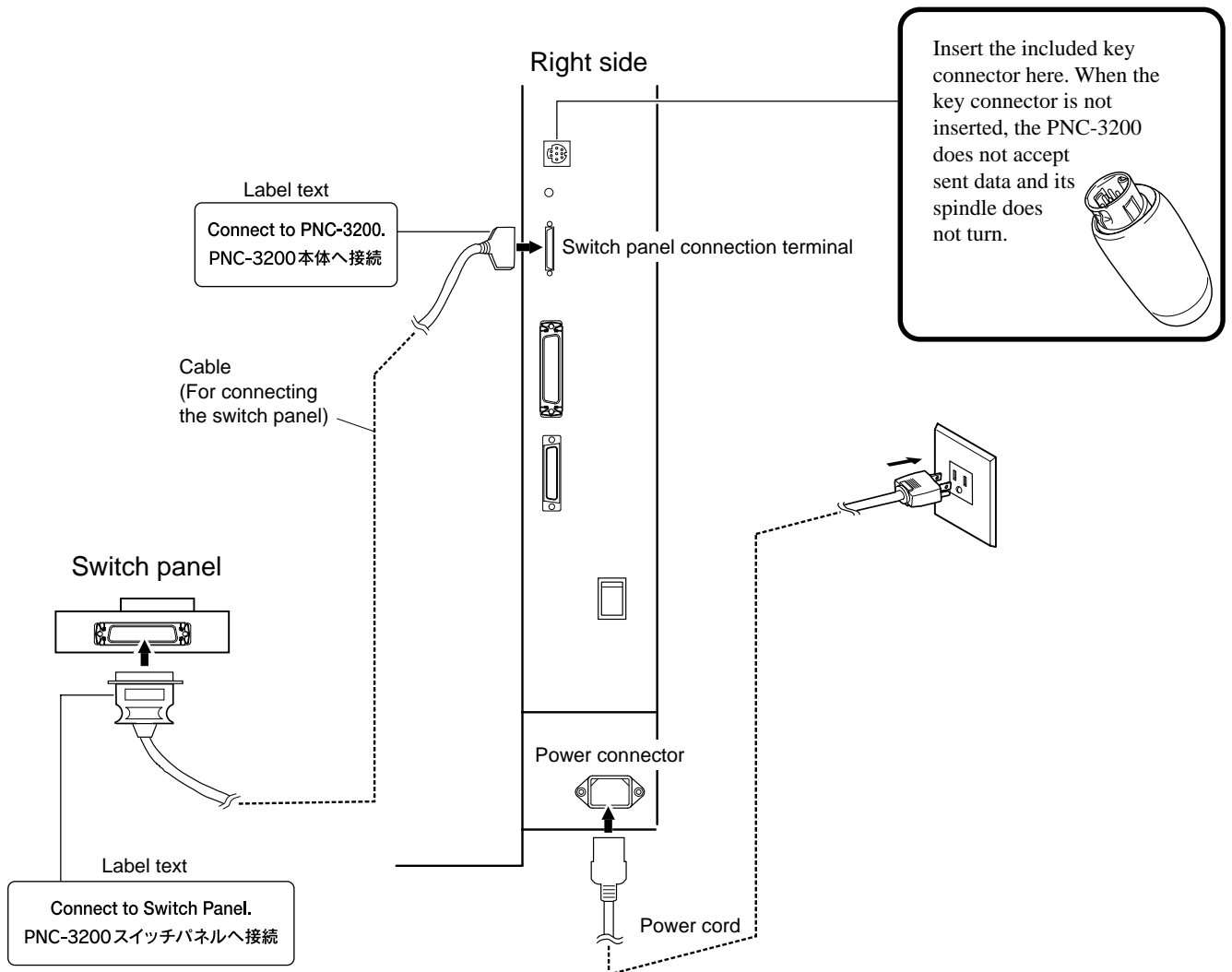

Connecting to a Computer

The cable for computer connection is optional. Please purchase the appropriate cable for the type of computer and software used.

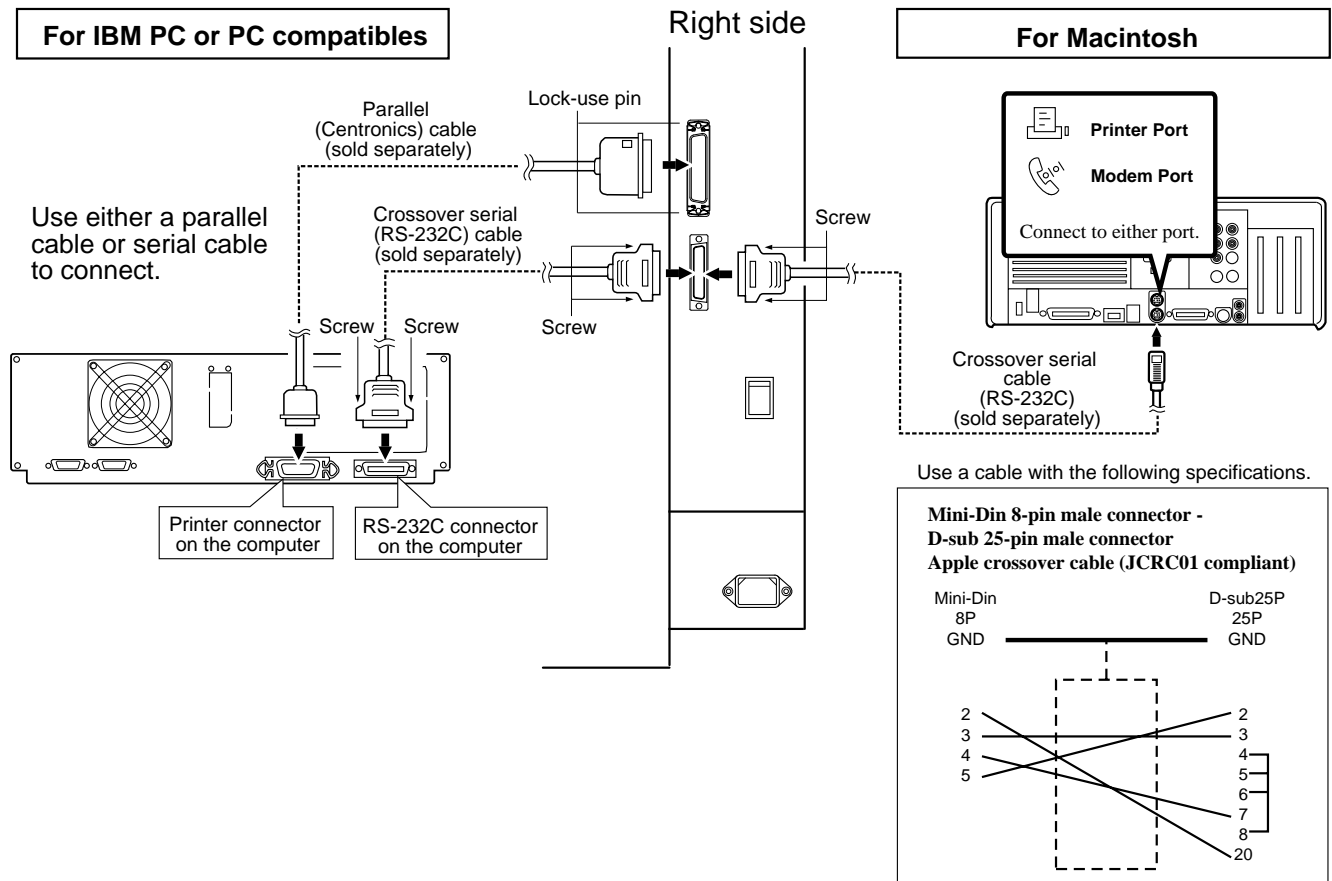

4 Installing the Software

Using with Windows®

The included CD-ROM contains several pieces of software for operating the PNC-3200. For information on how to use the programs, and for detailed information about their commands, see the help for the programs.

Operating environment

	MODELA Applications	Dr. Engrave	3D Engrave	Virtual MODELA
Computer	Personal computer running Windows 95, Windows 98, or Windows NT 4.0			
CPU	If you're using Windows 95: i486SX or better (Pentium 100 MHz recommended) If you're using Windows 98 or Windows NT 4.0: i486DX or better (Pentium 100 MHz recommended)			
System Memory	If you're using Windows 95: 8 MB or more (10 MB or more recommended) If you're using Windows 98 or Windows NT 4.0: 16 MB or more (32 MB or more recommended)			
Hard Disk	7 MB or more of free space	10 MB or more of free space	10 MB or more of free space	5 MB or more of free space

Setting Up the Program

* If you are installing under Windows NT 4.0, you need full access permissions for the printer settings. Log on to Windows NT as a member of the "Administrators" or "Power Users" group.

- 1 Switch on the computer and start Windows.
- 2 Place the CD from the Roland Software Package in the CD-ROM drive.
The Setup menu appears automatically.
- 3 When the screen shown below appears, click the ▼ in [Click here], then choose [PNC-3200].
Click [Install].
To view the description of a program, click the ⓘ button. To view the manual, click the ⓘ button.
(There are manuals in PDF format for the programs that the ⓘ button references. Acrobat Reader is required to view PDF files.)

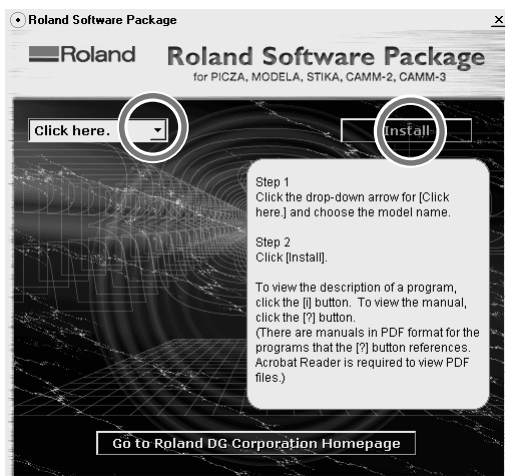

If there are programs you don't want to install, then clear their check boxes before you click [Install].

4 The Setup program starts. Follow the messages to carry out setup and finish setting up the program.

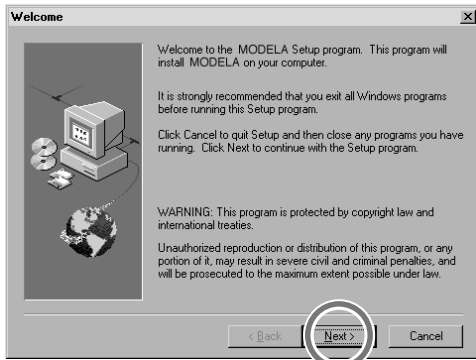

* When the setup for one program finishes, the setup for the next program starts. In the interval until the next setup starts, a dialog box showing the progress of processing is displayed.



5 If the following screen appears while installing the driver, click the drop-down arrow and choose the port for the cable connected to the computer.

When using an RS-232C (serial) cable
[COM1:] or [COM2:]
When using a printer (parallel) cable
[LPT1:] or [LPT2:]

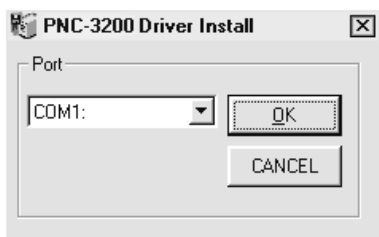

6 The driver settings appear. When you make the settings for the communication parameters of PNC-3200, make the parameters match the values displayed here. Click [Close] to finish installing the driver. The driver settings appear.

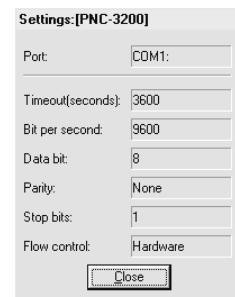

7 When all installation finishes, the screen shown below appears. Click [Close].



8 After returning to the menu screen for installation, click .



9 Remove the CD-ROM from the CD-ROM drive.

How to use Help

If you have trouble using the program or driver, see the help screens. Help contains information such as descriptions of software operation, explanations of commands, and tips for using the software more effectively.

- 1 From the [Help] menu, click [Contents].



- 2 Clicking on text that is green and underlined (by a solid or dotted line) displays an explanation.

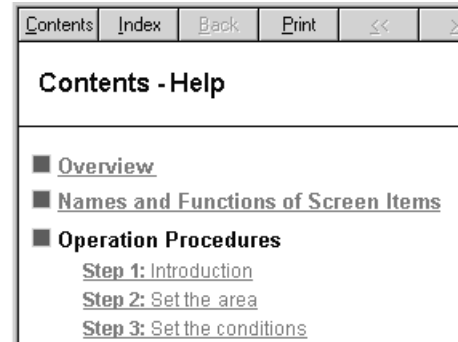

- 3 Clicking on an image area that contains an explanation displays the explanation.

Commands - [Edit] menu

Click on any item to learn more about it.

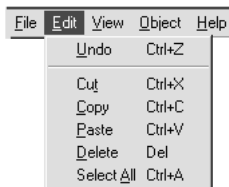

Tip

- When the pointer moves over green underlined text, it changes to a pointing hand (☞).
- When the pointer moves over a location where an explanation is included, it changes to a pointing hand (☞).

When there's a [?] button on screen

Clicking [?] in the upper-right corner of the window makes the mouse pointer change to a question mark (☞?). You can then move the ☞? pointer over any item you wish to learn more about, then click on the item to display an explanation of it.



When there's a [Help] button on screen.

Clicking [Help] lets you view help for the window or software.

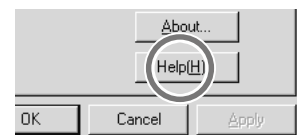

Using with Macintosh

The included CD-ROM contains programs for the Macintosh that output cutting data to modeling machines from Roland DG Corp. (such as the MODELA, CAMM-2, and CAMM-3). Set up MODELA Player for Mac OS from the included CD-ROM. For more information and details of commands on how to use MODELA Player for Mac OS, see the help screens.

Operating environment

- Computer A Power Macintosh, or PowerBook with a PowerPC processor.
- System Mac OS 7.5 or higher
- System Memory 20 MB or more (40 MB or more recommended)
- Hard Disk 3 MB or more of free space

Setting Up the Program

1 Turn off any virus-detection software.

2 Insert the included CD-ROM into the CD drive.

3 Double-click the CD icon to open.



4 Double-click the [Menu] icon.



5 When the screen shown below appears, click the allow in [Click here], then choose [PNC-3200]. Click [Install].
To view the description of a program, click the  button.

6 Follow the messages to carry out setup and finish setting up the program.
When installation is completed, remove the CD-ROM from CD-ROM drive.

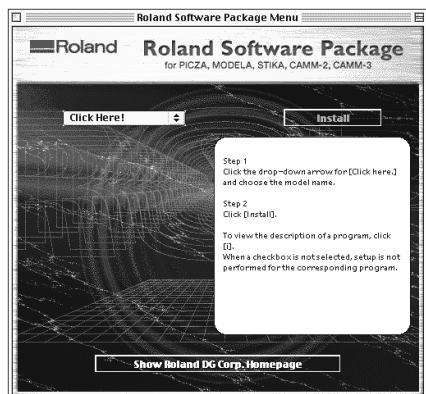

How to use Help

Help contains information such as explanations of MODELA PLAYER commands and tips for using MODELA PLAYER more effectively.

- 1 Open the [] menu and choose [MODELA PLAYER Help]. The MODELA PLAYER help screen appears.



- 2 For information on how to use help, see "Using Help."

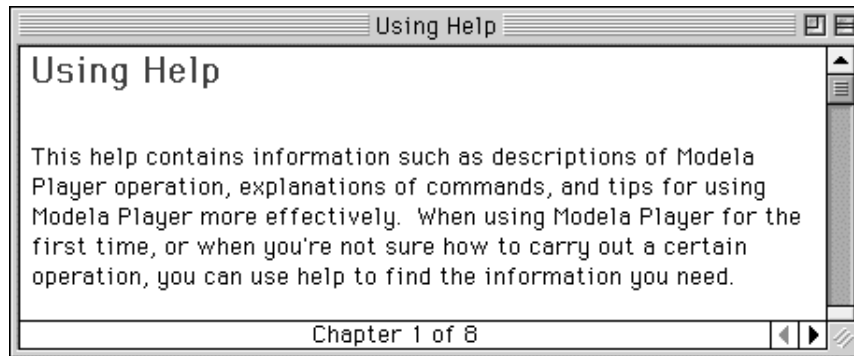

Settings for Communication Parameters

The settings are fixed at no parity, 8 bits, and one stop bit. For information about setting the bit rate (transmission speed), see the help screens.

5 Selection of the Command Set

On the PNC-3200, the first thing to do is to select the command set to use.

If You're Using PC

To perform output from the Windows program through the driver, choose "RML-1."

The driver is installed from the included Roland Software Package. For more information on how to install it, take a look at "4 Setting Up the Software."

If You're Using Macintosh

First, set up MODEL A Player for Mac OS from the included CD-ROM.

The selection made on the PNC-3200 depends on what model is set for MODEL A Player for Mac OS. When the model setting is for the 3200 (RML-1), select RML-1.

For more information, take a look at "4 Setting Up the Software" or the help files for the MODEL A Player for Mac OS.

Selecting the Command Set on the PNC-3200

Immediately after switching on the power, use the display to choose either RML-1 or NC code. Follow the steps below to choose the command set.

Once the command set has been selected, it can only be changed by switching the power off and on again. When you turn on the power, the display shows the command last selected in blinking text. If you don't want to change this command, press the [ENTER] key.

1 Switch on the power.

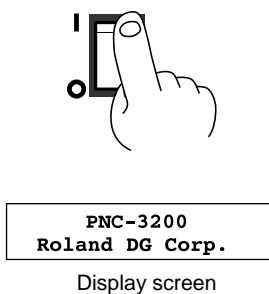

2 Use the [▶] key to move the flashing cursor ("█") to the command set, then press the [ENTER] key.

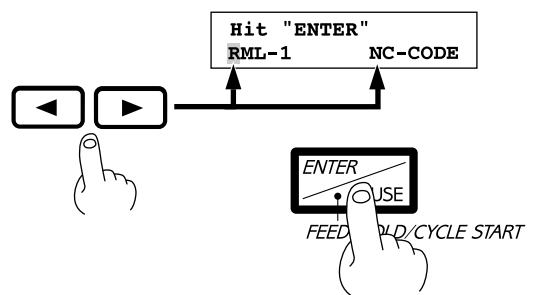

The operation method when performing cutting differs depending on whether you've selected RML-1 or NC code. For each respective operation method, refer to the separate "User's Manual 2 -- Cutting Using RML-1" or "User's Manual 3 -- Cutting Using NC Codes."

6 Setting the Connection Parameters

Connection with a parallel cable is called a "parallel connection," and connection with a serial cable is called a "serial connection." Make the appropriate settings on both the computer and the PNC-3200 to configure the equipment for the type of connection that has been made. Normally, the setting on the computer should be made to match the setting on the PNC-3200. The steps below describe how to set connection parameters on the PNC-3200. To make the settings on the computer, refer to the manual for the computer or the software in use.

If You've Selected RML-1

1 Press the [MENU] key to make the following screen appear on the display.

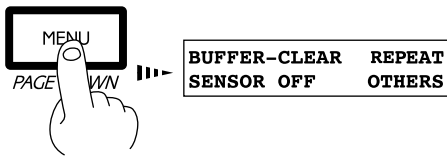

2 Press the [▶] key to move the blinking cursor ("█") to "OTHERS," and then press the [ENTER] key.

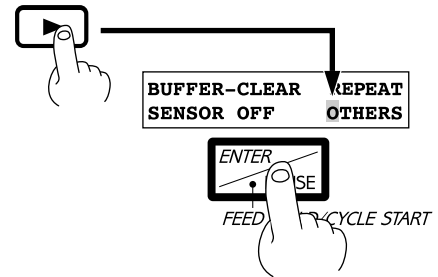

3 Press the [MENU] key to make the following screen appear on the display.

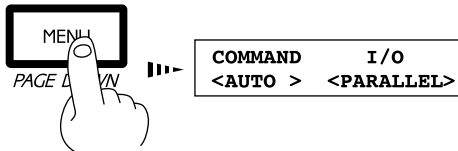

4 Press the [▶] key to move the blinking cursor ("█") to "I/O," then use the [▲] or [▼] keys to select "AUTO."

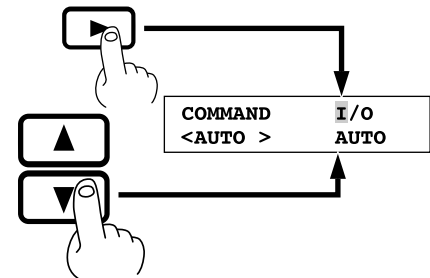

5 Press the [ENTER] key.

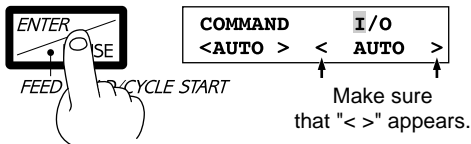

6 Press the [MENU] key once.

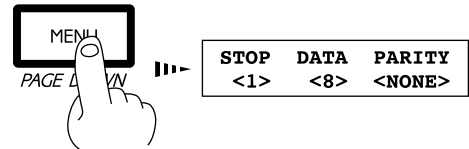

7 Make the settings for stop bit, data bits, and parity check, then press the [MENU] key once.

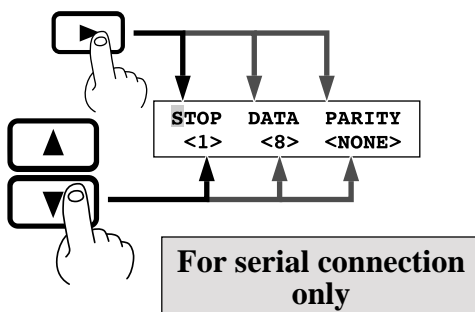

8 Make the settings for baud rate and handshake.

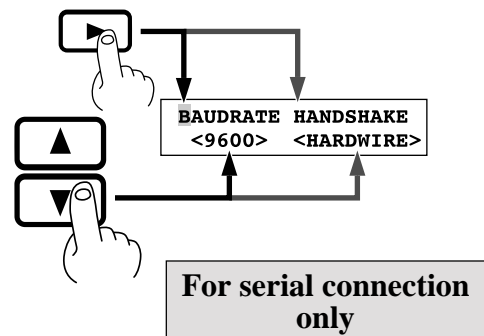

If You've Selected NC codes

- 1** Press the [PAGE DOWN] key to make the following screen appear on the display.

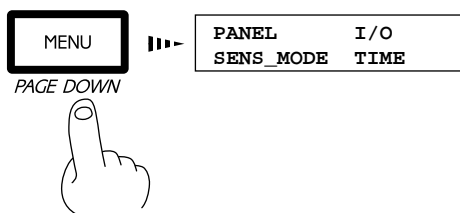

- 2** Press the [▶] key to move the blinking cursor (“█”) to “I/O,” and then press the [ENTER] key.

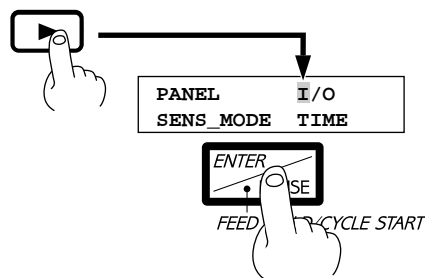

- 3** Press the [PAGE DOWN] key to make the following screen appear on the display.

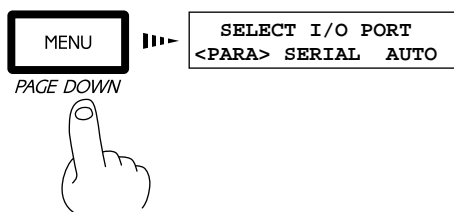

- 4** Press the [▶] key to move the blinking cursor (“█”) to “AUTO,” and then press the [ENTER] key.

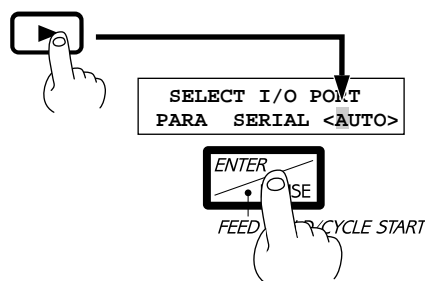

- 5** Press the [PAGE DOWN] key once.

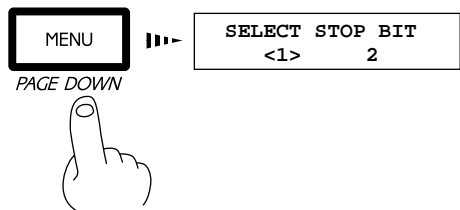

- 6** Use the [▶] key to move the blinking cursor (“█”) to the setting value, then press the [ENTER] key.

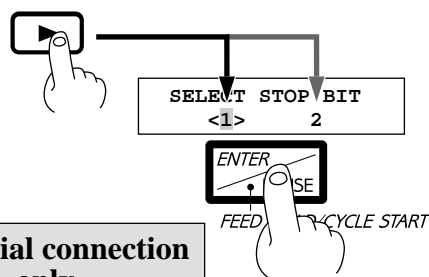

For serial connection only

For serial connection only

- 7** Press the [PAGE DOWN] key once, then set the data bit in the same way.

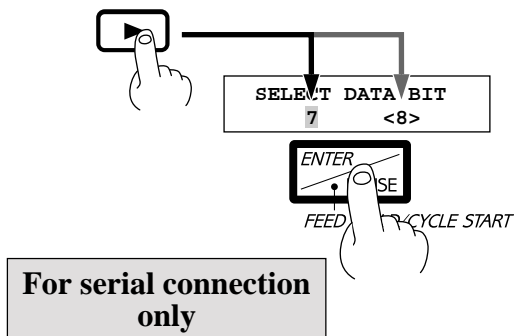

- 8** Make the settings for parity, bit rate, and handshaking in the same way.

For serial connection only

7 Loading a Workpiece for Cutting

⚠ CAUTION



Fasten the tool and material securely in place.

Otherwise they may come loose during cutting, resulting in injury.

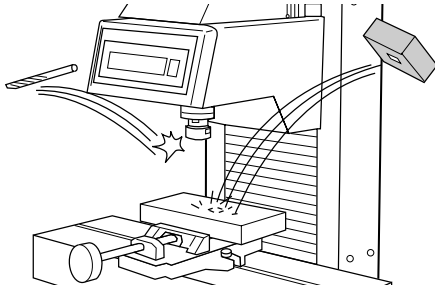

Do not place a load of 8 kg (17.6 lb.) or more (combined weight of the workpiece and vise) on the XY table.

The unit may tip over, resulting in injury.

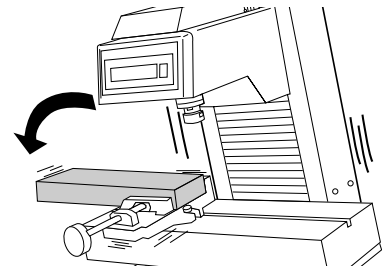

NOTICE

When mounting a vise or loading a workpiece while a tool is installed, take care to avoid being injured by the tool.

Before fixing the workpiece in place, take away any foreign matter such as cutting waste from the surface of the fixing-use block. If foreign matter remains, the workpiece may not be properly fixed and also the finished dimensions may not be precise.

This section is an explanation of the cutting workpiece attachment method when an optional machine vise ZV-1 is used. If employing an alternative attachment method, fix the workpiece firmly in place using the following explanation for reference.

Under the standard workpiece attachment method, a block is attached to the vise, then the workpiece is fixed to the block with double-sided adhesive tape. This is the most suitable method when cutting comparatively small workpieces. For the fixing-use block, it's better to choose a workpiece that can be cut and aligned horizontally with precision. (So that after attachment with the vise, accuracy can be improved when the surface is cut.) When cutting complicated shapes, it can be difficult to fix the workpiece to accommodate the cutting process. But with this method you can fix the workpiece setting position by cutting the block itself to the required shape.

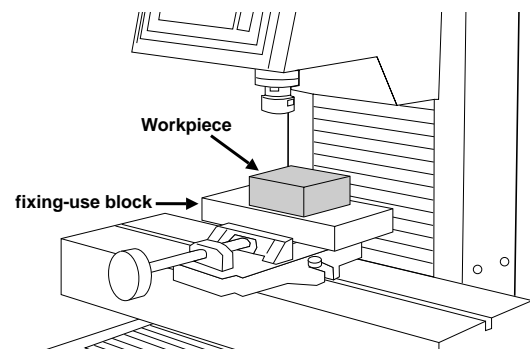

As an alternative, it is possible to attach the workpiece to the vise directly. Because no fixing-use block is utilized, this method is capable of accommodating larger workpieces. In addition, attachment and detachment are easy. However, this method is not suitable for very complicated shapes or for cases where the strength of the part held in the vise is weak. In cases where the workpiece is attached to the vise directly, be careful to adjust the cutting depth (the total Z axis feeding amount) so that the part of the workpiece held in the vise is not cut. If the tool cuts the vise, the cutting edge of the tool will be damaged and it will be impossible to use. Also, in the case of a very thin tool, the cutting edge may break and become very dangerous.

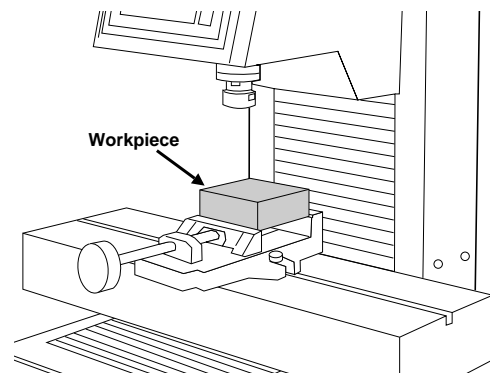

8 Cutting Tool Attachment

⚠ CAUTION

! When mounting or removing a tool, first switch off the spindle switch. Doing so may result in injury.

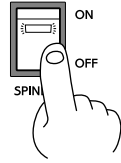

⊘ Do not touch the tip of the blade with your fingers. Doing so may result in injury.

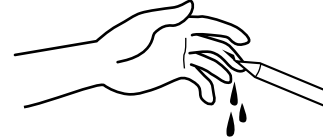

⊘ Do not touch the tool immediately after cutting operating stops. The tool may have become hot due to friction heat and may cause burns if touched.

! Fasten the tool and material securely in place. Otherwise they may come loose during cutting, resulting in injury.

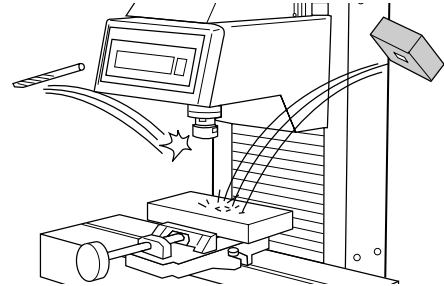

NOTICE Use the correct tool for the material to be cut and the cutting method.

Do not attempt to mount a collet chuck with no tool and tighten it with a wrench. Doing so may make it impossible to install a tool the next time used.

Use caution to prevent the cutting tool from falling out, otherwise the cutting tool may be damaged.

1 Set the SPINDLE switch on the front of the PNC-3200 to OFF.

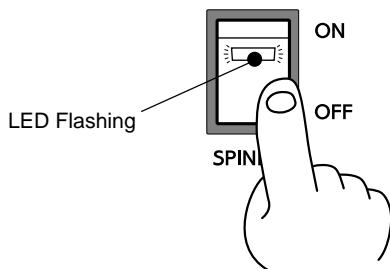

2 Loosen the collet chuck.

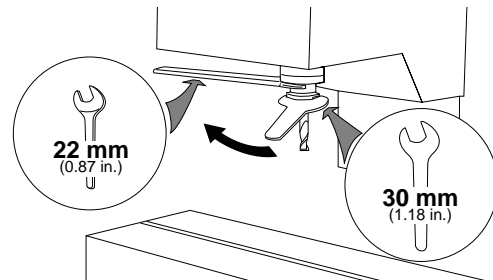

3 Insert the cutting tool.

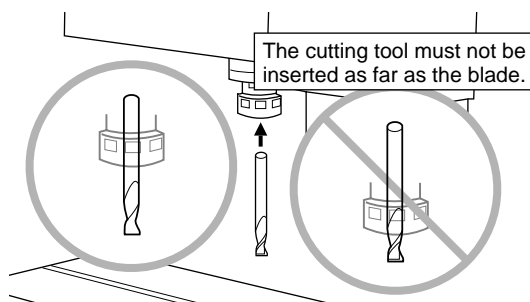

4 Tighten the collet chuck by hand to provisionally secure the cutting tool to the spindle motor.

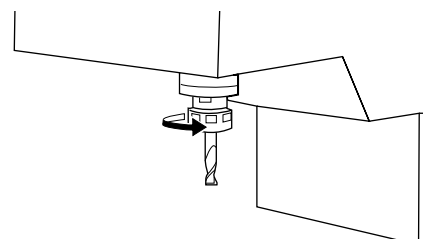

- 5** Secure the spindle motor so that it does not rotate, and use wrenches to tighten securely.

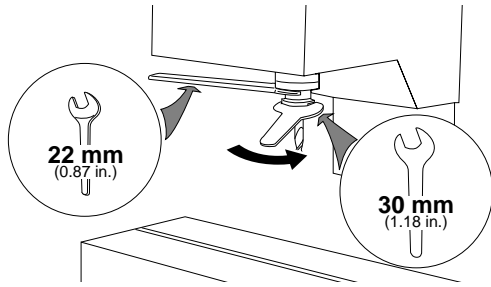

- 6** Set the SPINDLE switch to ON.

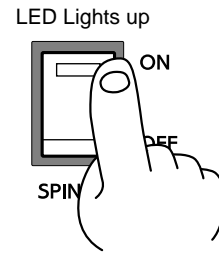

Changing the Collet Chuck

The collet chuck included as standard equipment with the machine can hold a cutting tool with a shank that is 6 mm (0.24 in.) in diameter. When using a cutting tool that has a different shank diameter, be sure to replace the collet chuck with one suited to the cutting tool's shank diameter. (Collet chucks for shank diameters other than 6 mm (0.24 in.) are available separately.)

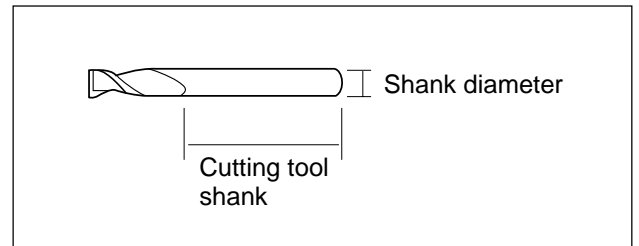

- 1** Rotate the collet cap to remove it.

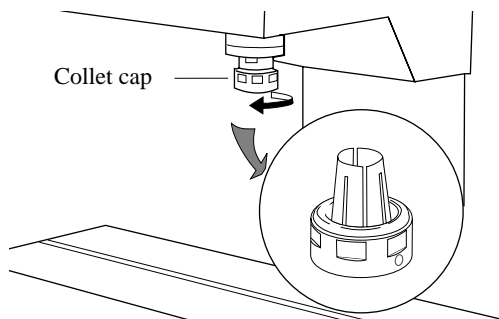

- 2** Tilt the collet chuck at an angle and remove while twisting.

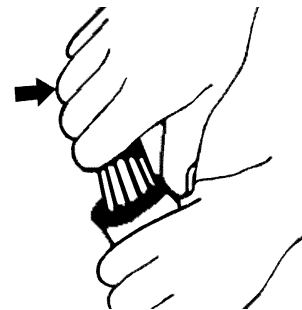

- 3** Securely fit the groove on the collet chuck to the tab on the cap.

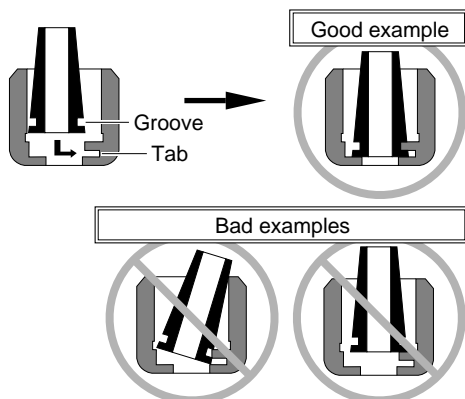

- 4** Install on the spindle.

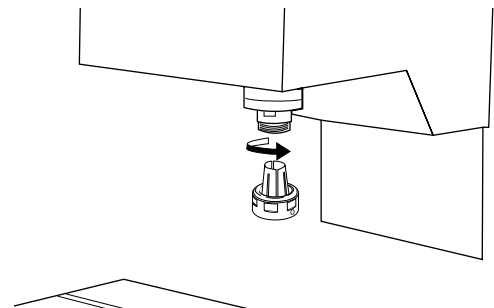

Maintenance

⚠ CAUTION



When cleaning, set the power switch on the unit to OFF.

Failure to do so may result in injury or electrical shock.



When you're finished, wash your hands to rinse away all cuttings.



Please use a vacuum cleaner to remove cutting dust.

Do not use any blower like airbrush. Otherwise, dust spread in the air may harm your health or damage this machine.

NOTICE

When opening the rear cover to clean the Z-axis portion, do not touch the interior with the hands.

Cleaning the Main Unit

When the main unit becomes dirty, use a dry cloth to wipe it.

Cleaning After Operation

After cutting work is completed, use a vacuum cleaner to clean the PNC-3200 main unit and the surrounding area of cutting dust. Be especially careful to remove the cutting waste from around the pleated part of the bellows cover. If necessary, move the XY table to the front and rear, and clean the entire cover. Except when moving the XY table, carry out all cleaning work with the PNC-3200's power OFF.

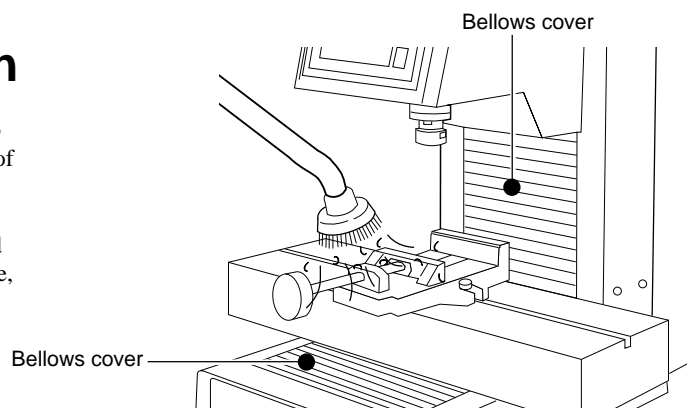

Open the cover at the rear of the unit and use vacuum cleaner to clean away any adhering cutting waste near the Z axis. For areas that are hard to reach with the vacuum cleaner, use a soft brush to dislodge the cutting waste, then vacuum it up with the vacuum cleaner.

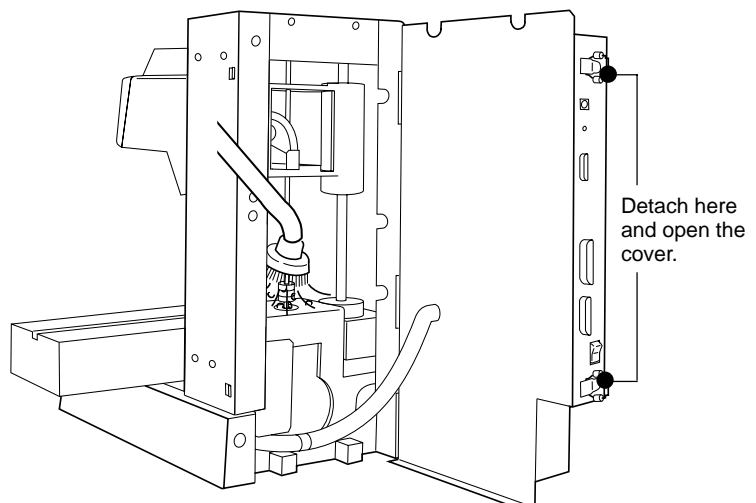

The above two cleaning operations are the only maintenance procedures that the customer needs to perform. Oil supply and other maintenance are not required.

Checking the Spindle Motor

Operate the spindle motor alone, with no tool installed or material loaded. If the rotation speed is uneven or marked noise is produced, be sure to contact a service technician.

Display of Spindle Rotation Time

The PNC-3200 has a function for the displaying the total rotation time of the spindle. The service life of the unit can be extended by carrying out periodic inspection. As a general guide, this inspection should be performed after every 500 hours of use. The method of operation differs according to the selected command set. The respective operation methods are described below.

If You've Selected RML-1

- 1 Press the [MENU] key to make the following screen appear on the display.

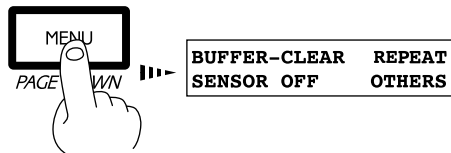

- 2 Press the [▶] key to move the blinking cursor ("█") to "OTHERS," and then press the [ENTER] key.

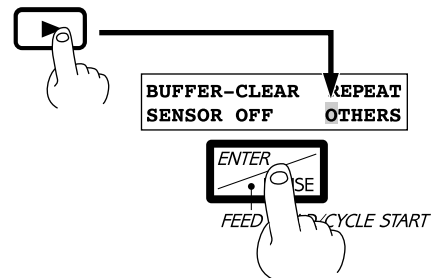

- 3 Press the [MENU] key to make the following screen appear on the display.

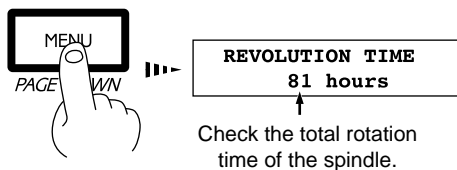

If You've Selected NC code

- 1 Press the [PAGE DOWN] key to make the following screen appear on the display.

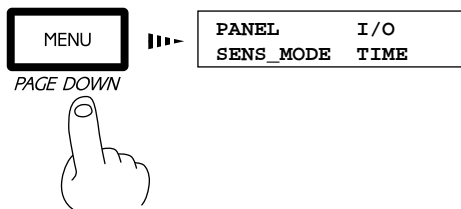

- 2 Press the [▶] key to move the blinking cursor ("█") to "TIME," and then press the [ENTER] key.

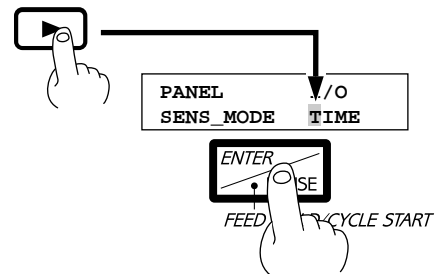

- 3 Check the total rotation time of the spindle.

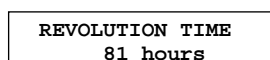

Recommended Service Checking

The PNC-3200 is a precision machine. In order to maintain it safely for operation over the long term, we recommend that it should be checked by a qualified serviceman. There is a charge for this service. Please take note of this in advance.

Maintenance to Be Performed by a Service Technician

- Inspection and maintenance at every 500 hours of spindle rotation time (refer to “Display of Spindle Rotation Time”)
- Checking and adjustment of the spindle belt
- Replacement of consumable parts (brushes, spindle belt, spindle motor, and spindle unit)

Specifications

		PNC-3200
XY table size		560 mm x 170 mm (22-1/16 x 6-11/16 in.)
Max. cutting area		250 mm(X) x 150 mm(Y) x 150 mm(Z) (9-13/16(X) x 5-7/8(Y) x 5-7/8(X) in.)
Feed rate		X, Y-axis: Max. 60mm/sec. (1-3/8 in./sec.) Z-axis: Max 30 mm/sec. (1-3/16 in./sec.)
Software resolution		[When RML-1 has been selected] 0.01 mm/step (0.00039 in.) [When NC codes has been selected] 0.001 mm/step (0.000039 in.)
Mechanical resolution		0.00125 mm/step
Spindle motor		180W (AC commutator motor)
Revolution speed		3000—8000 rpm (Variable manually or by the command set)
Positioning accuracy		±(Movement distance x 0.1%) mm (Under no-load conditions)
Repeat accuracy		±0.05 mm (0.00197 in.) (Under no-load conditions)
Possible table load weight		8 kg (17.6 lb.) or less, including mounting frame
Tool chuck		Collet system
Interface		Parallel (in compliance with the specification of Centronics) Serial (under RS-232C standard)
Buffer size		1 Mbyte (960 Kbyte for replot buffer)
Instruction system		RML-1 (mode1, mode2) or NC codes supported by the PNC-3200 (Selectable through display operation)
Control keys		[When RML-1 has been selected] Z0, Z1, Z2, HOME, ENTER/PAUSE, MENU, SPINDLE TEST ON/OFF, VIEW, ▲, ▼, ◀, ▶, +Z, -Z JOG/SPINDLE CONTROL, JOG HANDLE [When NC codes has been selected] DISPLAY, HOME, ENTER(FEED HOLD/CYCLE START), SPINDLE, PAGE UP, PAGE DOWN, VIEW, CANCEL, ▲, ▼, ◀, ▶, Z up, Z down, JOG, JOG HANDLE
Power consumption		2.4 A / 177 V 1.4 A / 220—230 V 1.3 A / 240 V
Acoustic noise level		During no-load operation: 65 dB (A) or less Standby mode: 44 dB (A) or less (According to ISO 7779)
Dimensions	Main unit	565 mm(W) x 722 mm(D) x 605 mm(H) (22-1/4(W) x 28-7/16(D) x 23-7/8(H) in.)
	Switch panel	341 mm(W) x 104 mm(D) x 49 mm(H) (13-7/16(W) x 4-1/8(D) x 1-15/16(H) in.)
Weight	Main unit	60 kg (132.3 lb.)
	Switch panel	1.5 kg (33.1 lb.)
Operation temperature		5—40°C (41—104°F)
Operation humidity		35—80% (no condensation)
Accessories		*ø6 Collet chuck: 1, *Collet cap: 1, Z0position sensor: 1, Power cord: 1, Cable(For connecting the switch panel): 1, Wrenches: 3(17 mm(0.67 in.), 22 mm(0.87 in.), 30 mm(1.18 in.)), T nuts: 2, Key connector: 1, USER'S MANUAL: 3(1 Setup & Maintenance, 2 Cutting Using RML-1, 3 Cutting Using NC codes), NC-code PROGRAMMER'S MANUAL: 1, Roland Software Package CD-ROM: 1, MODELA 3D DESIGN / MODELA 3D TEXT / MODELA Player User's Manual: 1

*... Installed on the unit.

Interface specifications

Parallel

Standard	In compliance with the specification of Centronics
Input signal	$\overline{\text{STROBE}}$ (1 BIT), $\overline{\text{DATE}}$ (8 BITE)
Output signal	$\overline{\text{BUSY}}$ (1 BITE), $\overline{\text{ACK}}$ (1 BIT)
Level of input/output signals	TTL level
Transmission method	Asynchronous

Serial

Standard	RS-232C specification
Transmission method	Asynchronous, duplex data transmission
Transmission speed	4800, 9600 (Selected using panel keys.)
Parity check	Odd, Even, None (Selected using panel keys.)
Data bits	7 or 8 bits (Selected using panel keys.)
Stop bits	1 or 2 bits (Selected using panel keys.)

Parallel connector (in compliance with specifications of Centronics)

Signal number	Terminal number	Signal number	Pin Connection
NC	36	18	HIGH**
HIGH*	35	17	GND
NC	34	16	GND
GND	33	15	NC
HIGH*	32	14	NC
NC	31	13	HIGH*
GND	30	12	GND
	29	11	$\overline{\text{BUSY}}$
	28	10	$\overline{\text{ACK}}$
	27	9	D7
	26	8	D6
	25	7	D5
	24	6	D4
	23	5	D3
	22	4	D2
	21	3	D1
	20	2	D0
19	1	$\overline{\text{STROBE}}$	

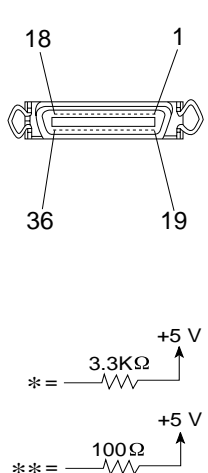

Serial connector (RS-232C)

Signal number	Terminal number	Signal number	Pin Connection
NC	25	13	NC
NC	24	12	NC
NC	23	11	NC
NC	22	10	NC
NC	21	9	NC
DTR	20	8	NC
NC	19	7	SG
NC	18	6	DSR
NC	17	5	CTS
NC	16	4	RTS
NC	15	3	RXD
NC	14	2	TXD
	1	1	FG

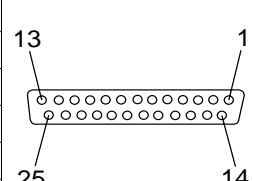

About the Expansion connector

The expansion connector (EXT.) is provided for expansion use by Roland DG Corp. Its specifications are proprietary. Roland DG Corp. assumes no responsibility for any effect on equipment due to the use of this port by the user.

Please read this agreement carefully before opening the sealed package or the sealed disk package

Opening the sealed package or sealed disk package implies your acceptance of the terms and conditions of this agreement. If you do NOT accept this agreement, retain the package UNOPENED. (This product is just one of included items. Please be aware that any amount of the purchase price will not be refunded for return of this product as a single item, regardless of whether the package is opened or unopened.) The enclosed Roland product is a single user version.

Roland License Agreement

Roland DG Corporation ("Roland") grants you a non-assignable and non-exclusive right to use the COMPUTER PROGRAMS in this package ("Software") under this agreement with the following terms and conditions.

- 1. Coming into Force**

This agreement comes into force when you purchase and open the sealed package or sealed disk package.
The effective date of this agreement is the date when you open the sealed package or sealed disk package.
- 2. Property**

Copyright and property of this Software, logo, name, manual and all literature for this Software belong to Roland and its licensor.

The followings are prohibited :

 - (1) Unauthorized copying the Software or any of its support file, program module or literature.
 - (2) Reverse engineering, disassembling, decompiling or any other attempt to discover the source code of the Software.
- 3. Bounds of License**

Roland does not grant you to sub-license, rent, assign or transfer the right granted under this agreement nor the Software itself (including the accompanying items) to any third party.
You may not provide use of the Software through time-sharing service and/or network system to any third party who is not individually licensed to use this Software.

You may use the Software by one person with using a single computer in which the Software is installed.
- 4. Reproduction**

You may make one copy of the Software only for back-up purpose. The property of the copied Software belongs to Roland.
You may install the Software into the hard disk of a single computer.
- 5. Cancellation**

Roland retains the right to terminate this agreement without notice immediately when any of followings occurs :

 - (1) When you violate any article of this agreement.
 - (2) When you make any serious breach of faith regarding this agreement.
- 6. Limitations on Liability**

Roland may change the specifications of this Software or its material without notice.

Roland shall not be liable for any damage that may caused by the use of the Software or by exercise of the right licensed by this agreement.
- 7. Governing Law**

This agreement is governed by the laws of Japan, and the parties shall submit to the exclusive jurisdiction of the Japanese Court.