

SOLJET PRO II

Sign Maker by Roland DG Corporation

SJ-1000

USER'S MANUAL

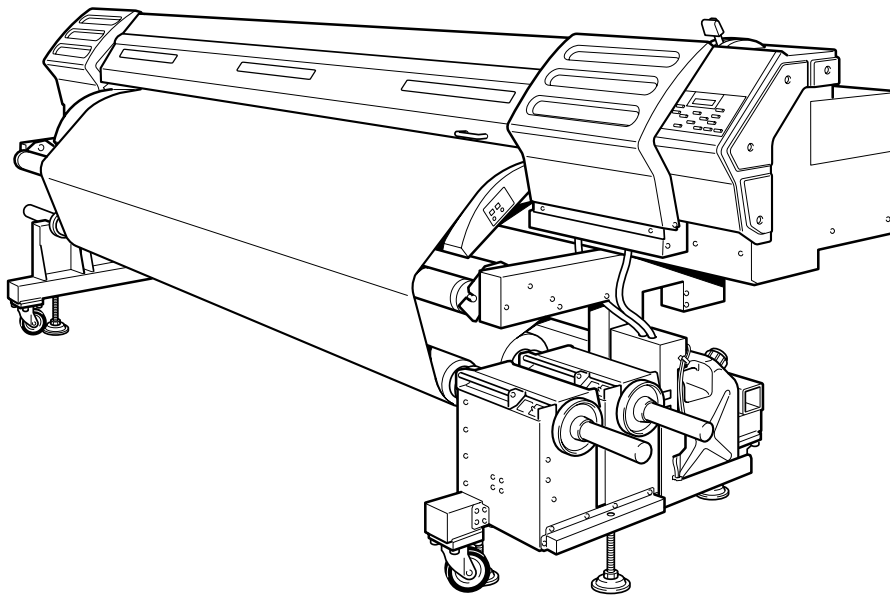

Thank you very much for purchasing this product.

- To ensure correct and safe usage with a full understanding of this product's performance, please be sure to read through this manual completely and store it in a safe location.
- Unauthorized copying or transferral, in whole or in part, of this manual is prohibited.
- The contents of this operation manual and the specifications of this product are subject to change without notice.
- The operation manual and the product have been prepared and tested as much as possible. If you find any misprint or error, please inform us.
- Roland DG Corp. assumes no responsibility for any direct or indirect loss or damage which may occur through use of this product, regardless of any failure to perform on the part of this product.
- Roland DG Corp. assumes no responsibility for any direct or indirect loss or damage which may occur with respect to any article made using this product.

For the USA

**FEDERAL COMMUNICATIONS COMMISSION
RADIO FREQUENCY INTERFERENCE
STATEMENT**

This equipment has been tested and found to comply with the limits for a Class A digital device, pursuant to Part 15 of the FCC Rules.

These limits are designed to provide reasonable protection against harmful interference when the equipment is operated in a commercial environment.

This equipment generates, uses, and can radiate radio frequency energy and, if not installed and used in accordance with the instruction manual, may cause harmful interference to radio communications.

Operation of this equipment in a residential area is likely to cause harmful interference in which case the user will be required to correct the interference at his own expense.

Unauthorized changes or modification to this system can void the users authority to operate this equipment.

NOTICE

Grounding Instructions

Do not modify the plug provided - if it will not fit the outlet, have the proper outlet installed by a qualified electrician.

Check with qualified electrician or service personnel if the grounding instructions are not completely understood, or if in doubt as to whether the tool is properly grounded.

Use only 3-wire extension cords that have 3-prong grounding plugs and 3-pole receptacles that accept the tool's plug.

Repair or replace damaged or worn out cord immediately.

For Canada

CLASS A NOTICE

This Class A digital apparatus meets all requirements of the Canadian Interference-Causing Equipment Regulations.

CLASSE A AVIS

Cet appareil numérique de la classe A respecte toutes les exigences du Règlement sur le matériel brouilleur du Canada.



ROLAND DG CORPORATION

1-6-4 Shinmiyakoda, Hamamatsu-shi, Shizuoka-ken, JAPAN 431-2103

MODEL NAME : See the MODEL given on the rating plate.

RELEVANT DIRECTIVE : EC LOW VOLTAGE DIRECTIVE (73/23/EEC)

EC ELECTROMAGNETIC COMPATIBILITY DIRECTIVE (89/336/EEC)

WARNING



This is a Class A product. In a domestic environment this product may cause radio interference in which case the user may be required to take adequate measures.



As an ENERGY STAR® Partner, Roland DG Corp. has determined that this product meets the ENERGY STAR® guidelines for energy efficiency.

The International ENERGY STAR® Office Equipment Program is an international program that promotes energy saving through the penetration of energy efficient computers and other office equipment. The program backs the development and dissemination of products with functions that effectively reduce energy consumption. It is an open system in which business proprietors can participate voluntarily. The targeted products are office equipment such as computers, monitors, printers, facsimiles, copiers, scanners, and multifunction devices. Their standards and logos are uniform among participating nations.

Contents

 To Ensure Safe Use	4
 Pour utiliser en toute sécurité	10
Important Notes on Handling and Use	16
Printer unit	16
Ink cartridges	16
Chapter 1 Introduction	17
1-1 Machine Features	18
1-2 Part Names and Functions	19
Printer Unit and Dryer	19
Printer Control Panel	21
Media Take-up and Feed Systems	22
Chapter 2 Operation	23
2-1 Switching the Power On and Off	24
Switching the Power On and Off	24
The Power-saving Feature	25
2-2 Loading and Cutting Off Media	26
How to Load Media	26
How to Cut Off Media	39
2-3 Settings of Preheater, Print Heater and Dryer	40
What Are the Preheater, Print Heater and Dryer?	40
Temperature Settings for the Preheater and Print Heater	41
Temperature Setting for the Dryer	41
General Guide for the Preset Temperatures	42
2-4 Starting Printing	43
Getting Ready to Receive Data from a Computer	43
Printing Tests and Cleaning	44
2-5 If Ink Runs Out	45
Checking for Remaining Ink	45
If Ink Runs Out	46
Chapter 3 Maintenance and Adjustment	49
3-1 Daily Care and Maintenance	50
Disposing of Discharged Ink	50
Cleaning	51
Care and Maintenance of the Print Heads	52
3-2 When Head Cleaning Is Not Effective	53
Performing More Powerful Cleaning	53
When Powerful Cleaning Is Not Effective	54
3-3 Cleaning the Heads Using the Cleaning Kit	55
When the Cleaning Kit Becomes Necessary	55
How to Perform Cleaning	55
3-4 Replacing Consumable Parts	59
Replacing the Wipers	59
3-5 When Not in Use for a Prolonged Period	61
Keep Performing Maintenance	61
Alarm Feature	61
Chapter 4 Feature Reference	63
4-1 Pausing or Canceling Printing	64
Canceling Printing Before It Finishes	64

4-2 Setting the Printing Position and Margins	65
Shifting the Print-start Position to the Rear	65
Shifting the Printing Position to the Left	65
Changing the Left and Right Margins	66
4-3 Optimizing Printing to Match Media Thickness	68
Adjusting Head Height to Match Media Thickness	68
Correcting for Misalignment in Bidirectional Printing	69
Saving Bidirectional Correction Values	72
Loading Bidirectional Correction Values	72
Performing Feed Correction to Alleviate Horizontal Bands and the Like	73
4-4 Accommodating Various Kinds of Media	75
Using Transparent Media	75
Printing Hard-to-dry Media	75
Speeding Up Printing for Narrow Media	76
Preventing Media from Coming Loose	77
Keeping Media from Being Soiled by Ink Drips	77
4-5 Changing How the Printer Operates	79
Determining What Happens When Ink Runs Out	79
Setting the Interval until Activation of the Sleep Mode	79
Deactivating the Sleep Mode	80
Changing the Menu Language and the Units of Measurement	80
Returning All Settings to Their Initial Values	81
Printing a System Report	81
4-6 Changing How the Preheater, Print Heater and Dryer Operate	82
Switching the Dryer On and Off	82
Switching Off the Preheater and Print Heater	82
Determining How the Preheater, Print Heater, and Dryer Operate	83
4-7 Menu List	84
Main menu	84
Language and Unit Menu	88
Cleaning and Maintenance Menu	88
Heater Configuration Menu	88
Chapter 5 What to Do If	89
5-1 The Machine Doesn't Run	90
The Printer Unit Doesn't Run	90
The Media Take-up or Feed System Doesn't Run	90
The Dryer Doesn't Warm Up	90
The Preheater and Print Heater Don't Warm Up	90
5-2 Attractive Printing Is Impossible	91
Printed Results Are Coarse or Contain Horizontal Stripes	91
Colors Are Unstable or Uneven	91
The Media Becomes Soiled When Printed	92
5-3 The Media Jams	93
The Media Jams	93
5-4 The Media Cannot Be Taken Up Smoothly	94
The Media Cannot Be Taken Up Smoothly	94
5-5 Media Wrinkles or Shrinks, or Feed Is Unstable	95
Media Wrinkles or Shrinks	95
The Media Is Not Straight	95
Media Feed Is Not Smooth	95
5-6 The Print Heads Stopped Moving	96
What to Do First	96
If the Heads Still Do Not Move	96
5-7 If a Message Appears	97
5-8 If an Error Message Appears	98

Chapter 6 Specifications 101

- 6-1 Usable Media 102
 - Conditions for Usable Media 102
- 6-2 Printing Area 103
 - Printing Area and Margins 103
- 6-3 Locations of the Power Rating and Serial Number Labels 104
- 6-4 Specifications 105

Company names and product names are trademarks or registered trademarks of their respective holders.



Copyright © 2004 Roland DG Corporation

<http://www.rolanddg.com/>







To Ensure Safe Use

Improper handling or operation of this machine may result in injury or damage to property. Points which must be observed to prevent such injury or damage are described as follows.

About WARNING and CAUTION Notices

 WARNING	Used for instructions intended to alert the user to the risk of death or severe injury should the unit be used improperly.
 CAUTION	Used for instructions intended to alert the user to the risk of injury or material damage should the unit be used improperly. * Material damage refers to damage or other adverse effects caused with respect to the home and all its furnishings, as well to domestic animals or pets.

About the Symbols

	The  symbol alerts the user to important instructions or warnings. The specific meaning of the symbol is determined by the design contained within the triangle. The symbol at left means "danger of electrocution."
	The  symbol alerts the user to items that must never be carried out (are forbidden). The specific thing that must not be done is indicated by the design contained within the circle. The symbol at left means the unit must never be disassembled.
	The  symbol alerts the user to things that must be carried out. The specific thing that must be done is indicated by the design contained within the circle. The symbol at left means the power-cord plug must be unplugged from the outlet.

Incorrect operation may cause injury

WARNING



Be sure to follow the operation procedures described in this manual.

Failure to follow the procedures may cause sudden operation or the like of the machine, which may result in unexpected injury.



Never allow anyone unfamiliar with the usage or handling of the machine to touch the machine.

Touching a dangerous location may cause sudden operation or the like of the machine, which may lead to an unexpected accident.



Never allow children near the machine.

The machine includes locations and components that pose a danger to children, and major accident, including injury, blindness, or choking, may occur.



Do not disassemble, repair, or modify.

Doing so may lead to fire or abnormal operation resulting in injury.

⚠ **This machine weighs 600 kg (1350 lb.). Media weighs 100 kg (220 lb.)**

⚠ WARNING



Never attempt to perform operations such as installation or relocation yourself.

This machine weighs approx. 455 kg (up to approx. 600 kg (1350 lb.), including media and the like), and moving it requires special equipment and training. Performing operations in an unreasonable manner may result in a major accident.



Install the machine in a location that is level, stable, and able to bear the weight of the machine.

This machine weighs approx. 455 kg (up to approx. 600 kg (1350 lb.), including media and the like). Installation in an unsuitable location may cause a major accident, including tipover, fall, or collapse.



After installation, keep the stand secured in place using the adjusters.

This machine weighs approximately 455 kg (up to approx. 600 kg (1350 lb.), including media and the like). If the machine should begin to topple, the tipover cannot be stopped with human strength, and a major accident may result, including crushing of the appendages or the body.

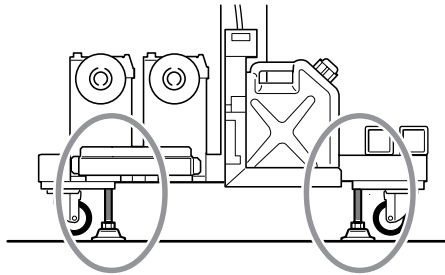

When loading or moving roll media, be sure to use load-handling equipment such as a lifter and carry out operations with care to prevent falls or other accidents.

Some roll media may weigh about 100 kg (220 lb.). Attempting manual lifting operations that tax your strength may cause physical injury. Also, if dropped, such items may cause unexpected injury, such as crushing of the feet.



When storing roll media, implement adequate safety measures to ensure that the stored media will not roll, fall, or topple over.

Some roll media may weigh about 100 kg (220 lb.), and becoming pinned under such media may cause major injury.

 **Danger of electrical short, shock, electrocution, or fire**

This machine carries a high current of a maximum of approximately 10 amperes. This can cause situations that could not occur with low-power equipment; use caution.

 **WARNING**



Do not use with any electrical power supply that does not meet the ratings displayed on the unit.

Use with any other power supply may lead to fire or electrocution.



Never operate the machine or insert or remove its power plug with wet hands.

Doing so may result in electrical shock or electrocution.



Never allow the machine to get wet, or apply gasoline, thinner, or any other flammable material to it.

Current leakage may cause electrical shock, electrocution, or combustion and fire.



Never allow hairpins, coins, matches, or any other object to get inside the machine through the ventilation ports.

Doing so may cause an electrical short, resulting in shock or electrocution, or the inserted object may catch fire.



Never place gasoline, alcohol, thinner, or any other flammable material near the machine, or use an aerosol spray close to the machine.

Doing so may cause fire.



Never damage the power cord or pull it with force.

Doing so may tear the cord's insulation, causing an electrical short and resulting in electrical shock, electrocution, or fire.



Never place any object on the power cord, bend the power cord using excessive force, or allow the power cord to become deformed.

The cord carries a high current of approximately 10 amperes. If it becomes deformed, the deformed location may grow hot and cause fire.



Never use the machine with the power cord bound into a bundle or roll.

The cord carries a high current of approximately 10 amperes. If the cord is in a bundle or roll, it may grow hot and cause fire.



Never use any power cord other than the power cord included with the machine. Also, never use a power strip or extension cord.

The cord carries a high current of approximately 10 amperes. The power strip or extension cord may grow hot and cause fire.



Do not use with a damaged power cord or plug, or with a loose electrical outlet.

Doing so may lead to fire, electrical shock, or electrocution.



When unplugging the electrical power cord from the power outlet, grasp the plug, not the cord.

Unplugging by pulling the cord may damage it, leading to fire, electrical shock, or electrocution.



Ground the unit with the ground wire.

Failure to do so may result in risk of electrocution in the event of a mechanical problem.



In the event of an abnormal state (such as smoke or sparks, odor or burning or unusual noise), immediately unplug the power cord.

Failure to do so may result in fire, electrical shock, or electrocution. Immediately disconnect the power cord and contact your Roland DG Corp. service center.

 **Ink, cleaning liquid, and discharged fluid are flammable and toxic**

 **WARNING**



Never operate in locations such as those near an open flame or heater, or where sparking or static electricity may occur.

Ink or the like may ignite and cause fire.



Never place ink, cleaning liquid, or discharged fluid in any of the following locations.

- **Near open flame**
- **In a hot location, such as near a heater or on the machine's platen or dryer**
- **Near bleach, chemicals, explosives, or the like**

Doing so may cause fire.

 **CAUTION**



Ensure adequate ventilation for the work area.

Odor from ink and the like may cause physical distress, or may cause to fire.



Never drink or sniff ink, cleaning liquid, or discharged fluid, or allow them to come in contact with the eyes or skin.

Doing so may be hazardous to your health.



Store ink cartridges in a location out of the reach of children.

 **In the Event of Ingestion or Physical Distress**

- In the event of contact with the eyes, immediately flush with running water for at least 15 minutes. If eye irritation continues, seek treatment by a physician.
- In the event of contact with skin, immediately wash with soap. If irritation or inflammation occur, seek treatment by a physician.
- In the event of ingestion, do not induce vomiting, and immediately seek treatment by a physician. Forcibly inducing vomiting may lead to danger of choking.
- If odor leads to physical distress, move to a well-ventilated location and rest quietly. If dizziness or nausea persists, seek treatment by a physician.

Danger of fire, burns, or toxic gas emissions

WARNING



This machine has high-temperature areas (platen and dryer). Exercise caution to avoid fire or burns.



Never leave media loaded in the machine when printing is not being performed.

The continued application of heat at a single location may cause fire or produce toxic gases. When printing is not being performed, switch off the power or remove any loaded media.



Never use media that cannot withstand the heat.

Doing so may result in fire or the release of toxic gases, or may degrade the media.



Never use the platen or dryer for any purpose for which they are not intended, such as to dry clothing.

Doing so may cause overheating, resulting in fire or accident.

Important Notes Regarding Operators and the Work Area

WARNING



Never operate the machine when tired or after ingesting alcohol or medications.

Operation requires lifting heavy objects and unimpaired judgment, and unexpected injury may result.



Conduct operations in a clean, brightly lit location.

Working in a location that is dark or cluttered can be hazardous. Operations in such locations may cause an accident, such as tripping and becoming pinned under the roll media.

CAUTION



Never attempt operation while wearing a necktie, necklace, loose clothing, or the like. Bind long hair securely.

Such items may become caught in the media take-up system or other areas, resulting in injury.



Never climb or lean on the machine.

The machine is not made to support a person. Climbing or leaning on the machine may move away components and cause in a slip or fall, resulting in injury.

⚠ Warning Labels

Warning labels are affixed to make areas of danger immediately clear. The meanings of these labels are as follows. Be sure to heed their warnings. Also, never remove the labels or allow them to become obscured.

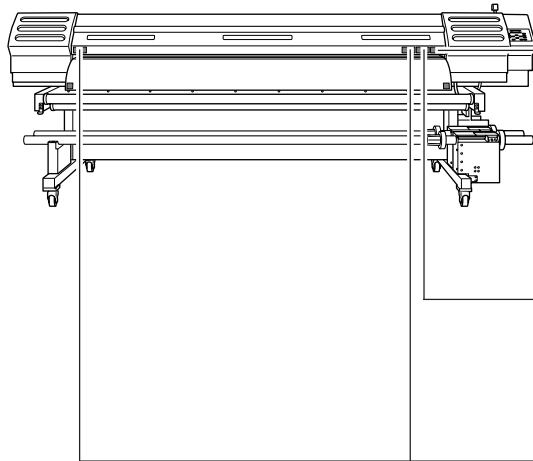

Flammable

Ink and discharged fluid are flammable. Keep away from open flame.



Ink Is Toxic

Ink and discharged fluid are toxic. Avoid contact with the body. Use only in a well-ventilated area.



Caution: Moving Print Heads

The print heads inside the cover move at high speed and pose a hazard. Never insert the hand or fingers into the gap.



Caution: Pinching Hazard

Be careful not to allow the fingers to become pinched when closing the cover.

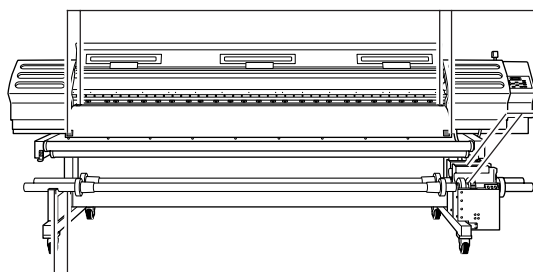

Caution: High Temperature

The platen and dryer become hot. Exercise caution to avoid fire or burns.



Caution: Pinching Hazard

Be careful not to allow the fingers to become pinched when loading media or closing covers.



Flammable

Ink and discharged fluid are flammable. Keep away from open flame.



Ink Is Toxic

Ink and discharged fluid are toxic. Avoid contact with the body. Use only in a well-ventilated area.

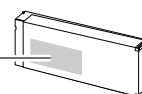
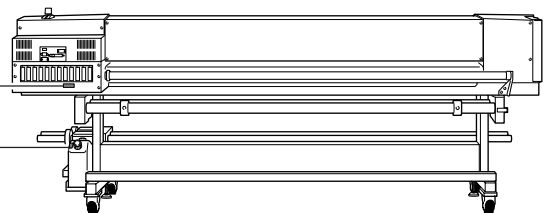



Ink cartridge



Pour utiliser en toute sécurité

La manipulation ou l'utilisation inadéquates de cet appareil peuvent causer des blessures ou des dommages matériels. Les précautions à prendre pour prévenir les blessures ou les dommages sont décrites ci-dessous.

Avis sur les avertissements

 ATTENTION	Utilisé pour avertir l'utilisateur d'un risque de décès ou de blessure grave en cas de mauvaise utilisation de l'appareil.
 PRUDENCE	Utilisé pour avertir l'utilisateur d'un risque de blessure ou de dommage matériel en cas de mauvaise utilisation de l'appareil. * Par dommage matériel, il est entendu dommage ou tout autre effet indésirable sur la maison, tous les meubles et même les animaux domestiques.

À propos des symboles

	Le symbole \triangle attire l'attention de l'utilisateur sur les instructions importantes ou les avertissements. Le sens précis du symbole est déterminé par le dessin à l'intérieur du triangle. Le symbole à gauche signifie "danger d'électrocution".
	Le symbole \circ avertit l'utilisateur de ce qu'il ne doit pas faire, ce qui est interdit. La chose spécifique à ne pas faire est indiquée par le dessin à l'intérieur du cercle. Le symbole à gauche signifie que l'appareil ne doit jamais être démonté.
	Le symbole \bullet prévient l'utilisateur sur ce qu'il doit faire. La chose spécifique à faire est indiquée par le dessin à l'intérieur du cercle. Le symbole à gauche signifie que le fil électrique doit être débranché de la prise.

L'utilisation incorrecte peut causer des blessures

ATTENTION



S'assurer de suivre les procédures d'utilisation décrites dans ce manuel.

Si les procédures indiquées ne sont pas suivies, le fonctionnement de l'appareil peut être déclenché soudainement, ce qui risque de causer des blessures.



Ne jamais permettre à quiconque de toucher l'appareil s'il ou si elle n'en connaît pas le fonctionnement ou la maintenance.

Toucher l'appareil à certains points dangereux peut en déclencher le fonctionnement, ce qui risque de causer un accident imprévu.



Ne jamais laisser d'enfants s'approcher de l'appareil.

Des éléments et des surfaces de l'appareil présentent des risques pour les enfants. Il pourrait se produire un accident grave qui causerait des blessures, ou créerait un risque de cécité ou de suffocation.



Ne pas démonter, réparer ni modifier.

Démonter, réparer ou modifier l'appareil risque de provoquer un incendie ou de causer un fonctionnement anormal entraînant des blessures.

⚠ **Le poids de cet appareil est de 600 kg (1350 lb.)
Le poids du support est de 100 kg (220 lb.)**

⚠ ATTENTION



Ne jamais tenter de procéder seul à des opérations comme l'installation ou le déplacement de l'appareil.

Le poids de cet appareil est d'environ 455 kg (jusqu'à environ 600 kg (1350 lb.), y compris le support et d'autres éléments); il faut une formation et de l'équipement spéciaux pour déplacer l'appareil. Tenter de procéder à ces opérations de manière intempestive peut provoquer un accident grave.



Installer l'appareil à un endroit stable et plat et capable de supporter son poids.

Le poids de cet appareil est d'environ 455 kg (jusqu'à environ 600 kg (1350 lb.), y compris le support et d'autres éléments). Installer l'appareil à un endroit inapproprié peut provoquer un accident grave comme le renversement, la chute ou l'écrasement.



Une fois l'appareil installé, solidifier la base à l'aide des éléments de réglage ajustables.

Le poids de cet appareil est d'environ 455 kg (jusqu'à environ 600 kg (1350 lb.), y compris le support et d'autres éléments). Si l'appareil commence à basculer, aucune force humaine ne peut l'empêcher de se renverser; il s'ensuivrait un accident grave, par exemple l'écrasement d'un membre ou du corps.

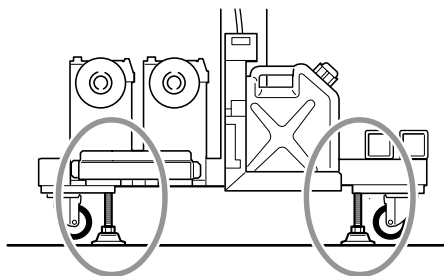

Lors du chargement ou du déplacement du support en roulement, utiliser de l'équipement de levage comme et prendre des précautions pour éviter les chutes et autres accidents.

Le poids de certains supports en roulements peut être de quelque 100 kg (220 lb.). Tenter de soulever manuellement des objets trop lourds peut causer des blessures. En outre, si ces objets sont échappés, ils peuvent causer des blessures, par exemple écraser les pieds.



Il faut prendre les mesures de sécurité adéquates pour l'entreposage des rouleaux de support pour s'assurer qu'ils ne rouleront pas, ne tomberont pas et ne se renverseront pas.

Certains rouleaux de support pèsent quelque 100 kg (220 lb.), et rester coincé sous un rouleau peut causer des blessures graves.

Risque de décharge ou de choc électrique, d'électrocution ou d'incendie

Cet appareil transmet une tension élevée (maximum d'environ 10 ampères). Cela peut créer des situations qui ne se produisent pas avec de l'équipement à basse tension. La prudence est de mise.

ATTENTION



Ne pas utiliser avec une source d'alimentation électrique non conforme à la norme indiquée sur l'appareil.

Utiliser l'appareil avec une autre source d'alimentation risque de provoquer un incendie ou de causer une électrocution.



Ne jamais utiliser l'appareil, insérer la prise dans le réceptacle ou l'en enlever si on a les mains mouillées.

Il y a risque de décharge électrique ou d'électrocution.



Ne jamais permettre que l'appareil soit mouillé; ne jamais y appliquer d'essence, de diluant ni aucun matériau inflammable.

Une fuite de courant peut causer un choc électrique, l'électrocution ou la combustion et un incendie.



Ne jamais laisser des épingles à cheveux, des pièces de monnaie, des allumettes ni aucun autre objet pénétrer dans l'appareil par les orifices de ventilation.

Cela crée un risque de décharge électrique ou d'électrocution. En outre, les objets peuvent prendre feu.



Ne jamais placer de l'essence, du diluant ni aucun matériau inflammable près de l'appareil; ne jamais utiliser de produits en aérosol près de l'appareil.

Cela crée un risque d'incendie.



Ne jamais endommager le câble d'alimentation ni le tirer vigoureusement.

Cela risque de déchirer l'isolant du câble et de causer un court-circuit, ce qui aurait comme résultat un choc électrique, l'électrocution ou un incendie.



Ne jamais placer d'objets sur le cordon d'alimentation, plier le câble d'alimentation en utilisant une force excessive ni laisser le câble d'alimentation se déformer.

Le câble transmet un courant de forte intensité, soit environ 10 ampères. Si le câble se déforme, la section affectée peut surchauffer et causer un incendie.



Ne jamais utiliser l'appareil si le câble d'alimentation est attaché ou enroulé.

Le câble transmet un courant de forte intensité, soit environ 10 ampères. S'il est attaché ou enroulé, il peut surchauffer et causer un incendie.



Ne jamais utiliser un cordon d'alimentation autre que celui qui est fourni avec l'appareil. Ne jamais non plus utiliser de bande d'alimentation électrique ni de rallonge.

Le câble transmet un courant de tension élevée (environ 10 ampères). La bande d'alimentation ou la rallonge peuvent surchauffer et causer un incendie.



Ne pas utiliser si le fil ou la fiche électriques sont endommagés; ne pas brancher dans une prise mal fixée.

Négliger de suivre cette consigne risque de provoquer un incendie ou de causer une décharge électrique ou une électrocution.



Pour débrancher l'appareil, saisir la fiche et non le fil électrique.

Tirer sur le fil peut l'endommager, ce qui risque de provoquer un incendie ou de causer une décharge électrique ou une électrocution.

ATTENTION



Mettre l'appareil à la terre avec le fil de mise à la terre.

Ne pas respecter cette consigne peut créer un risque d'électrocution en cas de panne mécanique.



S'il se produit quoi que ce soit d'anormal (fumée, étincelles, odeur, combustion ou bruit inhabituel), débrancher immédiatement le câble d'alimentation.

Le défaut de ce faire peut entraîner un incendie, un choc électrique ou l'électrocution. Débrancher immédiatement le câble d'alimentation et communiquer avec le Centre de services Roland DG.

L'encre, les liquides nettoyants et les liquides usés sont inflammables et toxiques

ATTENTION



Ne jamais utiliser l'appareil près d'une flamme nue ou d'un appareil de chauffage ou dans des endroits où la production d'étincelles ou d'électricité statique peut survenir.

L'encre ou les autres produits combustibles peuvent s'enflammer et causer un incendie.



Ne jamais placer d'encre, de liquide de nettoyage ou des liquides usés dans les endroits suivants :

- > près d'une flamme nue
- > dans un endroit chaud, par exemple près d'un appareil de chauffage, sur la platine ou la surface de séchage de l'appareil;
- > près de javellisants, de produits chimiques, d'explosifs ou d'autres produits semblables

Cela crée un risque d'incendie.

PRUDENCE



S'assurer que le lieu de travail est bien aéré.

L'odeur de l'encre et des autres produits peut causer des troubles physiques ou provoquer un incendie.



Ne jamais boire l'encre, le liquide de nettoyage ni les liquides usés, ne pas en respirer les vapeurs et ne pas laisser les produits entrer en contact avec les yeux ou la peau.

Cela est dangereux pour la santé.



Entreposer les cartouches dans un endroit hors de la portée des enfants.

En cas d'ingestion ou de trouble physique

- > En cas de contact avec les yeux, rincer immédiatement et abondamment à l'eau courante pendant au moins 15 minutes. Si les yeux sont toujours irrités, consulter un médecin.
- > En cas de contact avec la peau, laver immédiatement à l'eau et au savon. Si la peau devient irritée ou inflammée, consulter un médecin.
- > En cas d'ingestion, ne pas provoquer le vomissement et demander immédiatement l'aide d'un médecin. Provoquer le vomissement peut créer un risque de suffocation.
- > Si l'odeur cause un trouble physique, amener la personne dans un endroit bien aéré et la faire se reposer. Si l'étourdissement ou les nausées persistent, consulter un médecin.

Risque d'incendie, de brûlures ou d'émissions de gaz toxiques

ATTENTION



Certaines surfaces de cet appareil atteignent des températures élevées (platine et surface de séchage). Prendre des précautions pour éviter un incendie ou des brûlures.



Ne jamais laisser de support dans l'appareil quand aucune impression n'est en cours.

L'application continue de chaleur au même endroit peut provoquer un incendie ou l'émission de gaz toxiques. Quand l'appareil n'est pas utilisé, couper l'alimentation ou retirer les supports qui y sont chargés.



Ne jamais utiliser un support qui ne peut pas supporter la chaleur.

L'utilisation de supports qui ne supportent pas la chaleur peut causer un incendie, provoquer l'émission de gaz toxiques ou affecter le support.



Ne jamais utiliser la platine et la surface de séchage à des fins autres que celles pour lesquelles ils sont conçus, par exemple, ne pas les utiliser sécher des vêtements.

L'utilisation à ces fins risque de causer une surchauffe et de provoquer un incendie ou un accident.

Remarques importantes sur les opérateurs et le lieu de travail

ATTENTION



Ne jamais faire fonctionner l'appareil en état de fatigue, ni après avoir consommé de l'alcool ou des médicaments.

L'utilisation de l'appareil exige que l'opérateur soulève des objets lourds; par conséquent, l'opérateur peut se blesser s'il n'est pas en possession de tous ses moyens.



Utiliser l'appareil dans un endroit propre et bien éclairé.

Travailler dans un endroit sombre ou encombré peut créer des risques. Utiliser l'appareil dans de tels endroits risque de causer un accident, par exemple un faux pas, une chute et rester coincé sous le rouleau de support.

PRUDENCE



Ne jamais faire fonctionner l'appareil si on porte une cravate, un collier, des vêtements amples ou autres du même genre. Bien attacher les cheveux longs.

Les cravates, colliers, vêtements amples ou cheveux peuvent être entraînés dans le système d'alimentation du support ou par d'autres éléments, ce qui risque de causer des blessures.



Ne jamais grimper ni s'appuyer sur l'appareil.

L'appareil n'est pas conçu pour supporter le poids d'une personne. Grimper ou s'appuyer sur la machine peut déplacer des éléments et causer un faux pas ou une chute, ce qui causerait des blessures.

⚠ Vignettes d'avertissement

Des vignettes d'avertissement sont apposées pour qu'il soit facile de repérer les zones dangereuses. La signification des vignettes est donnée ci-dessous. Respecter les avertissements. Ne jamais retirer les vignettes et ne pas les laisser s'encrasser.

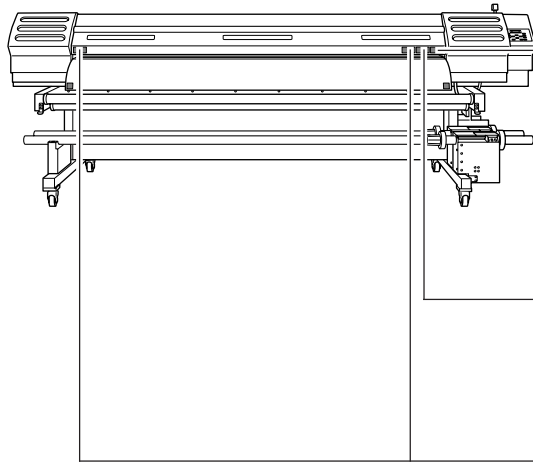

Inflammable

L'encre et les liquides usés sont inflammables. Les garder loin de toute flamme nue.



L'encre est toxique

L'encre et les liquides usés sont toxiques. Éviter tout contact avec le corps. Utiliser uniquement dans un endroit bien aéré.

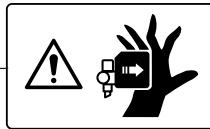

Attention : Têtes d'impression mobiles

Les têtes d'impression sous le couvercle se déplacent à haute vitesse et représentent un danger. Ne jamais insérer la main ou les doigts dans l'ouverture.

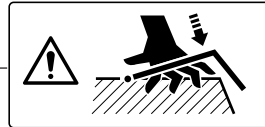

Attention : Risque de pincement

Faire attention de ne pas coincer les doigts lors de la fermeture du couvercle.

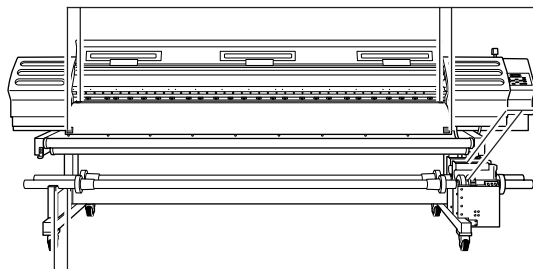

Attention : Température élevée

La platine et la surface de séchage chauffent. Être prudent pour éviter un incendie ou des brûlures.



Attention : Risque de pincement

Faire attention de ne pas coincer les doigts pendant le chargement du support ou lors de la fermeture du couvercle.



Inflammable

L'encre et les liquides usés sont inflammables. Les garder loin de toute flamme nue.



L'encre est toxique

L'encre et les liquides usés sont toxiques. Éviter tout contact avec le corps. Utiliser uniquement dans un endroit bien aéré.

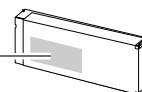
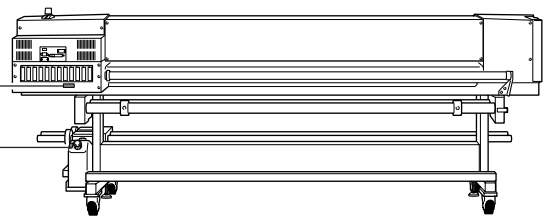

La cartouche d'encre

Important Notes on Handling and Use

This machine is a precision device. To ensure the full performance of this machine, be sure to observe the following important points. Failure to observe these may not only result in loss of performance, but may also cause malfunction or breakdown.

Printer unit

This Machine Is a Precision Device

- Handle carefully, and never subject the machine to impact or excessive force.
- Never needlessly put your hand or fingers inside the cover, the ink-cartridge ports, or other internal areas of the machine.

Install in a Suitable Location

- Install in a location having the specified temperature and relative humidity.
- Install in a quiet, stable location offering good operating conditions.

The Print Heads Are Delicate

- Never needlessly touch or allow media to scrape them. Failure to handle with care may cause damage.
- The print heads may be damaged if allowed to dry out. The machine prevents desiccation automatically, but improper operation may render this feature inoperative. Operate properly, as specified in this manual.
- Never allow the machine to stand with an ink cartridge removed. Remaining ink in the printer may harden and clog the print heads.
- The print heads are components that wear out. Periodic replacement is required, with the frequency of replacement depending on use.

This Machine Becomes Hot

- Never cover the ventilation holes with cloth, tape, or anything else.

When Moving the Machine

- Special preparations are required when moving the machine. Please check with your authorized Roland DG Corp. dealer or Roland DG Corp. service center ahead of time.

Ink cartridges

Ink Cartridges Come in Various Types

- Use a type that is compatible with the printer. Also, be sure to use only genuine items from Roland DG Corp.

Never Subject to Impact or Attempt to Disassemble

- Never drop or shake forcefully. The impact may rupture the internal pouch and cause the ink to leak.
- Never attempt to disassemble.
- Never attempt to refill the ink.
- If ink gets on your hands or clothing, wash it off as soon as possible. Removal may become difficult if allowed to stand.

Storage

- Store unopened in a well-ventilated location at a temperature of -20 to 40°C (-4 to 104°F).

Chapter 1

Introduction

I-I Machine Features

This machine is a high-speed, large-format printer compatible with media having a width of 100 inches. It provides ample image quality for large outdoor signs and the like even in its fastest mode, demonstrating high practicality and productivity. It is provided with the necessary features for high-speed, high-volume printing, including a media feed and take-up systems and media dryer.

Also, despite being an ink-jet printer, it achieves output of high weatherability thanks to the use of ECO-SOL inks.

I-2 Part Names and Functions

Printer Unit and Dryer

Front Cover

Be sure to close this when you perform printing.

Loading Lever

You operate this when you load media.

Operation Panel

You use this to perform various operations. See p 21 "Printer Control Panel"

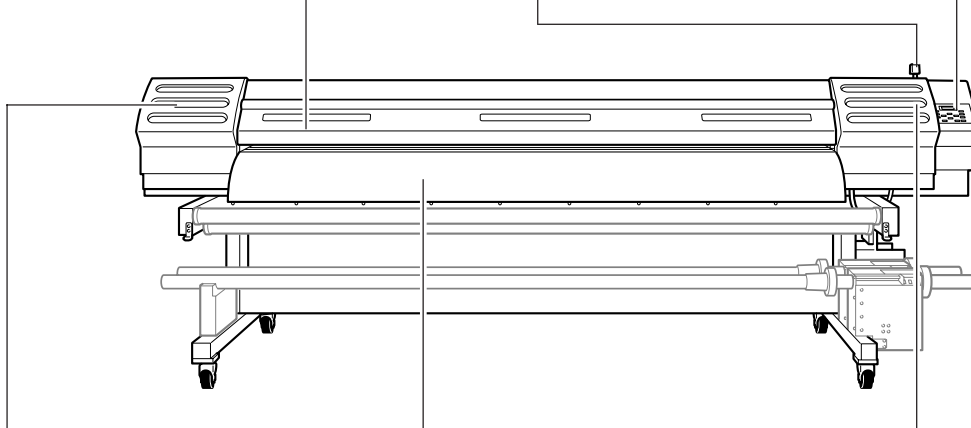

Left Side Cover

You remove this when you perform maintenance.

Dryer

This heats the media to hasten ink-drying.

Right Side Cover

You remove this when you perform maintenance.

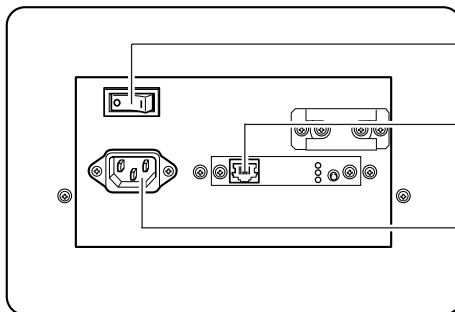

Printer Main Power Switch

This is the main power switch for the printer unit.

Ethernet Connector

This is used to connect the printer to a network.

Power-cord Connector

This supplies power to the printer unit, dryer, and media take-up and feed systems. A 200 to 240 V electrical outlet is required.

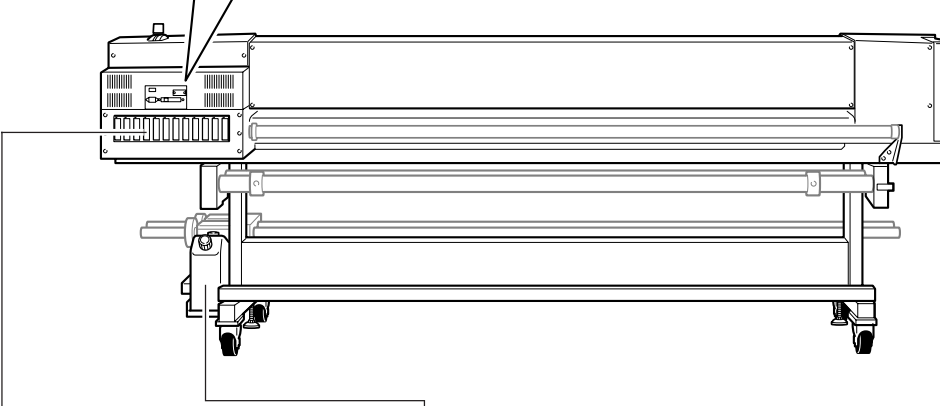

Cartridge Slots

This is where ink cartridges are installed.

Drain Bottle

This collects drained ink and other such fluids. Discard any collected fluid before it overflows.

I-2 Part Names and Functions

Platen

This is the path over which the media passes. A suction fan that keeps the media from coming loose and a preheater and print heater that help fix the ink are built in.

Media Clamps

These keep the media from coming loose and prevent fuzz on the cut edge of the media from touching the print heads.

Pinch Rollers

These clamp the media when the loading lever is pulled back toward you.

Grit Rollers

These rollers feed out media toward the front of the machine.

Knife Guide

The media can be cut off with a straight edge by inserting a retractable knife into this groove.

Print-head Carriage

The print heads are inside this.

Guide Line

This line serves as a guide for positioning the right edge of the media.

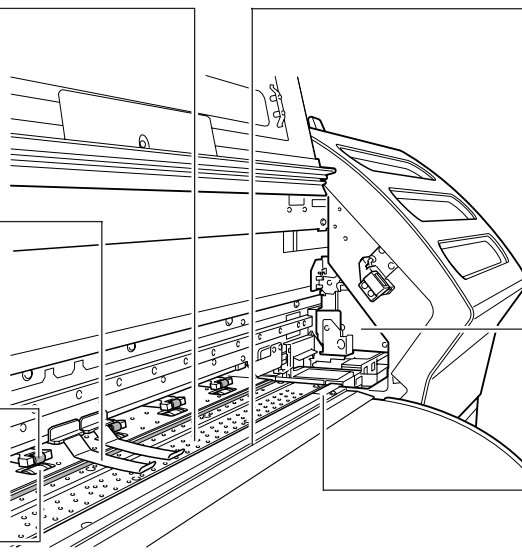

Actual Temperature

This displays the current temperature of the dryer.

Preset Temperature

This displays the preset temperature.

Temperature Setting keys

These set the temperature for the dryer.

Dryer Main Power Switch

This is the main power switch for the dryer. It shares the power-cord connector with the printer unit.

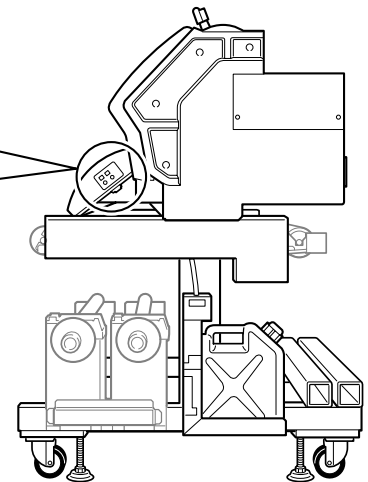
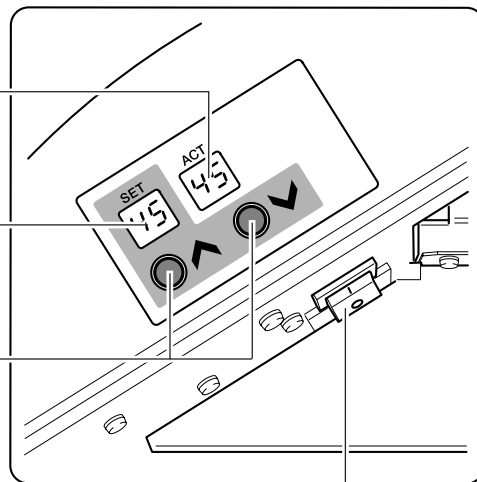



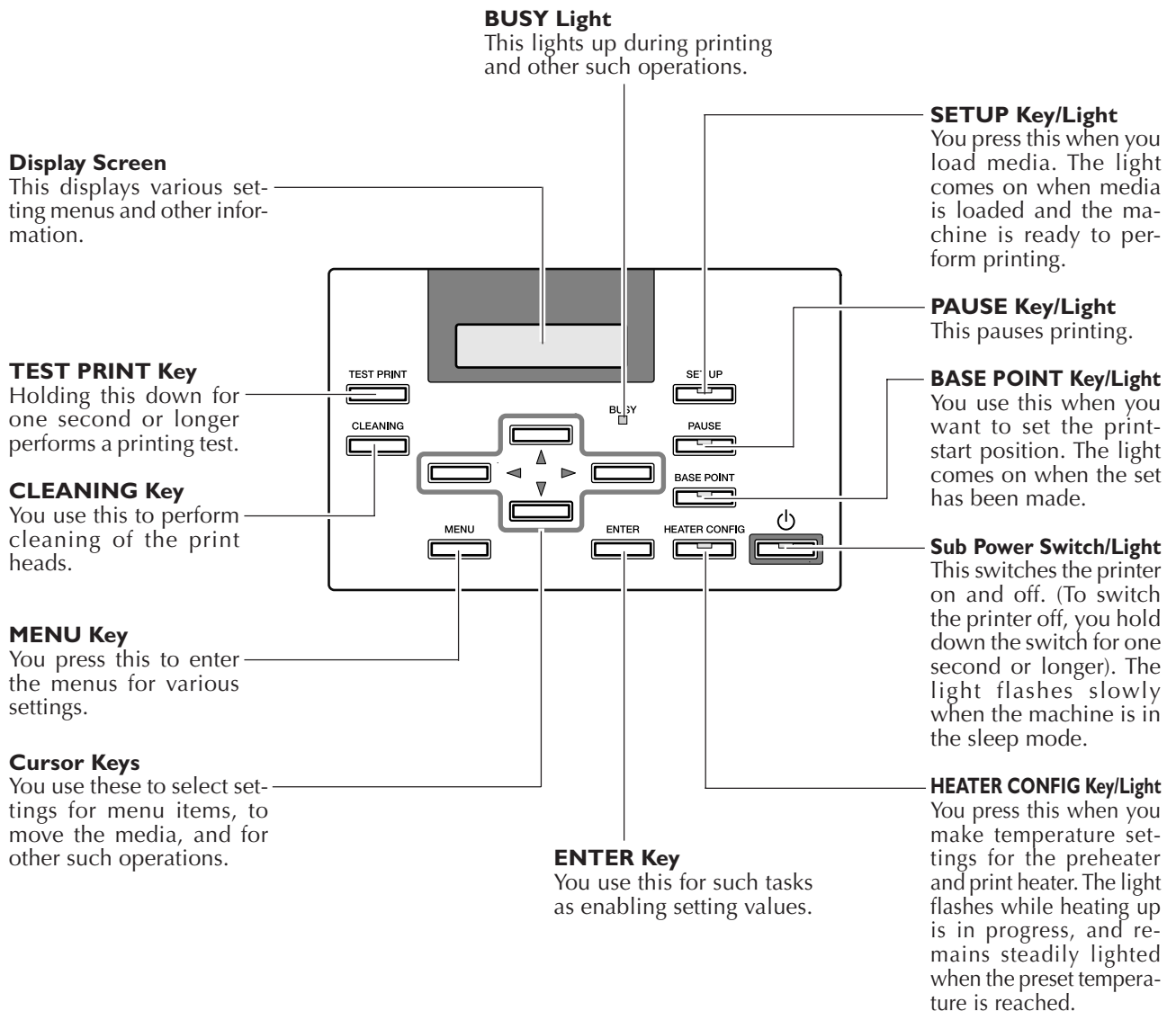









Printer Control Panel



Panel Notation

In this document, the keys and lights on the control panel are indicated by the following images.

	SETUP Key/Light
	MENU Key
	HEATER CONFIG Key/Light
	ENTER Keys
   	Cursor Keys
	PAUSE Key/Light
	TEST PRINT Key
	CLEANING Key
	BASE POINT Key/Light

Media Take-up and Feed Systems

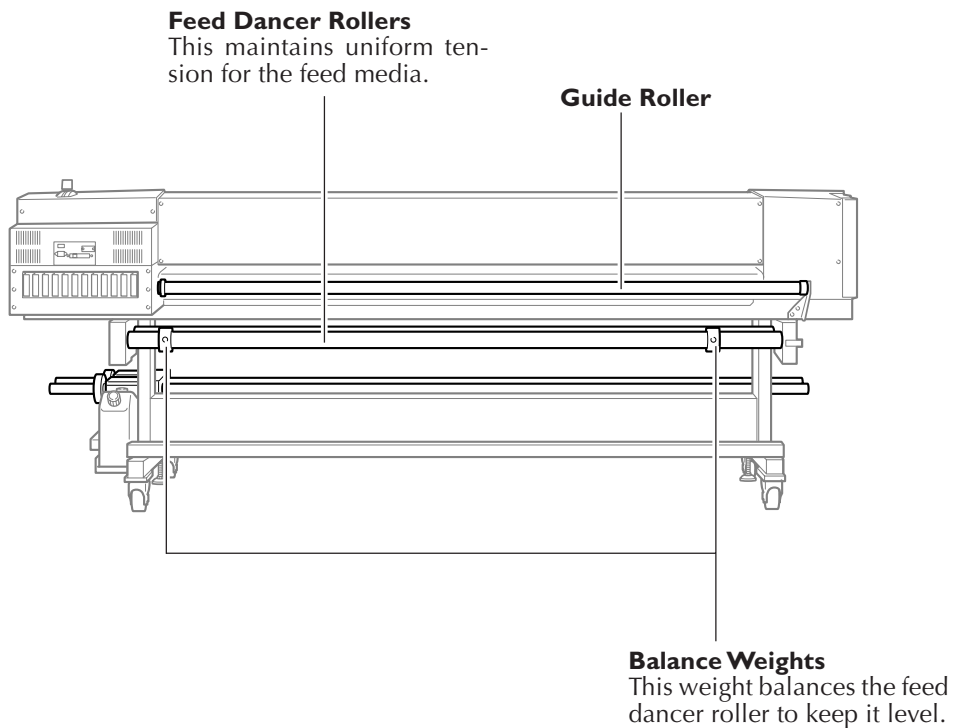
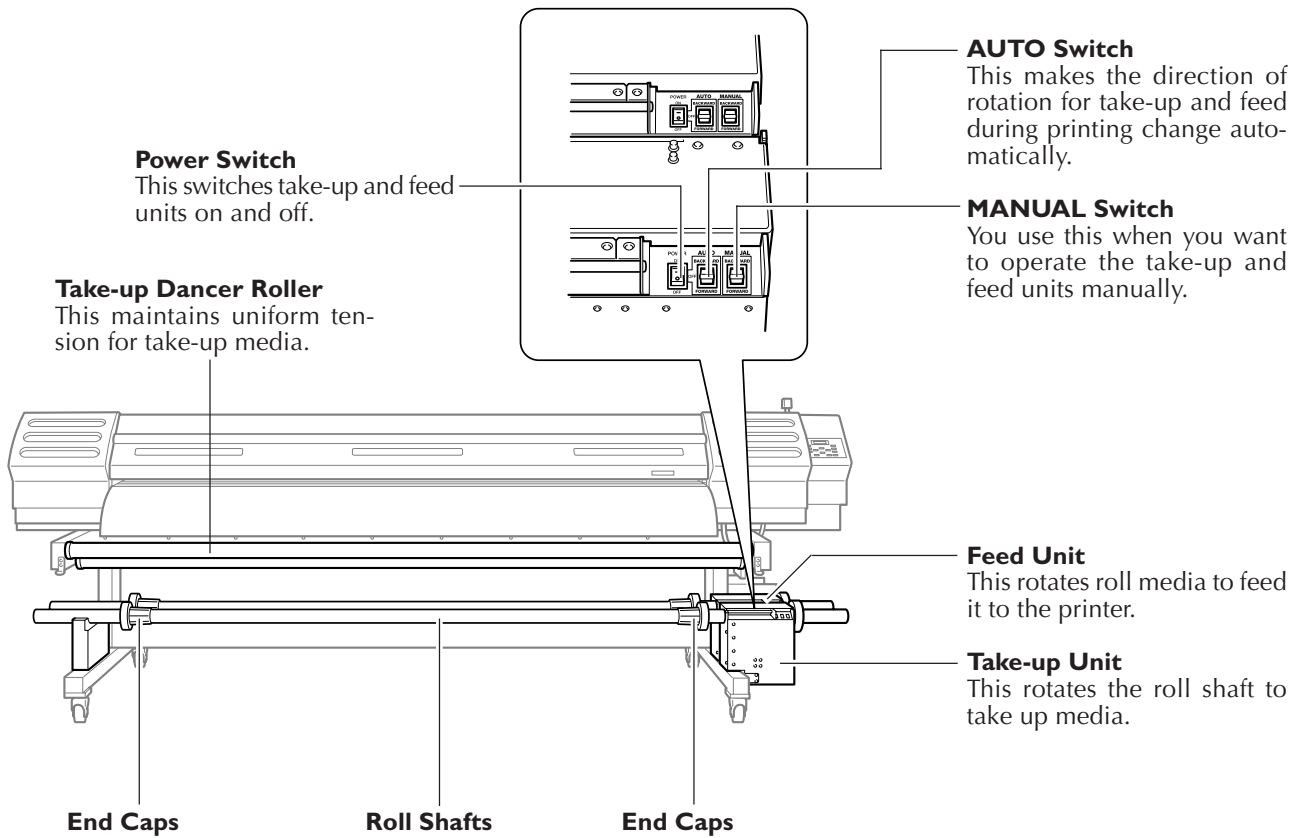

Chapter 2

Operation

2-1 Switching the Power On and Off

Switching the Power On and Off

This machine has four power switches. You switch on all four when using the machine. When you finish printing, you turn off switches 2, 3, and 4 as required. You also flip down the loading lever to the rear of the machine.

⚠ WARNING When leaving the printer unattended after completing operation, be sure to turn off the power to the machine.

Failure to do so may lead to overheating of the platen or dryer, resulting to fire. Also, inadvertent contact by someone other than the operator may result in sudden operation of the machine, leading to injury or burns.

We recommend leaving this switched on at all times during ordinary day-to-day operation. (The machine monitors the dryness of the print heads which this switch is on.)

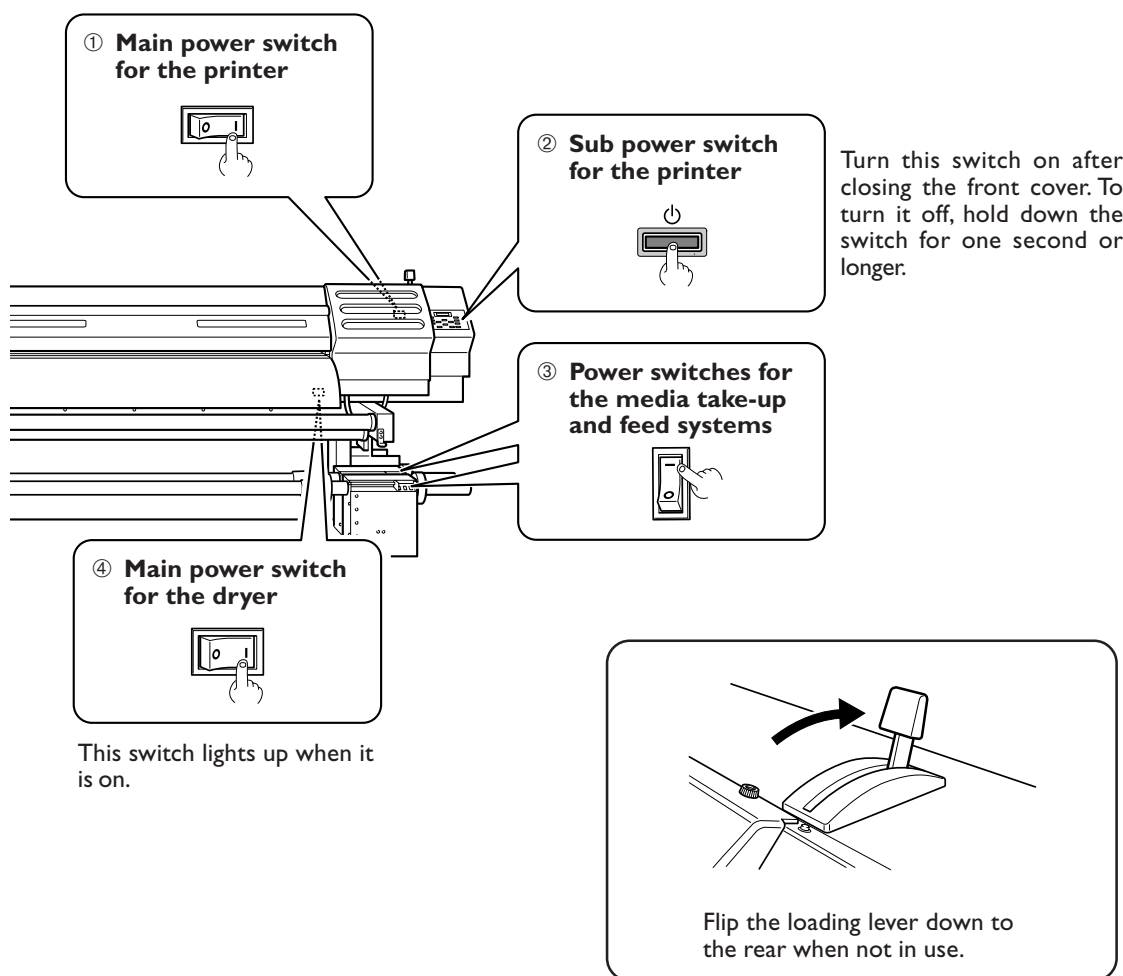

Important Note on Switching Off the Power

Never switch off the printer's main power or unplug the power cord suddenly while operation is in progress. Doing so may damage the print heads. Be sure to first switch off the sub power. If the main power is accidental switched off, immediately turn the main power and sub power back on.

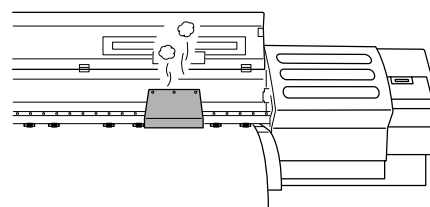

The Power-saving Feature

This machine is provided with a power-saving feature that switches to a low-power "sleep mode" when a fixed interval passes with no operation. The factory default for the time after which the machine switches to the sleep mode is 30 minutes.

You can change the setting for the time of the shift to the sleep mode. You can also switch off the power-saving feature.

☞ p 79 "Setting the Interval until Activation of the Sleep Mode"

☞ p 80 "Deactivating the Sleep Mode"

When the machine is in the sleep mode, the POWER light flashes slowly and the heating devices stop.

Using the control panel or performing operations such as sending printing data from the computer (when media is loaded) restore the machine to its normal mode.

To reduce power consumption and prevent problems such as overheating, we recommend leaving the power-saving feature on and setting the activation time for the sleep mode to 30 minutes or less.

2-2 Loading and Cutting Off Media

How to Load Media

- ⚠️ WARNING** When loading or moving roll media, be sure to use load-handling equipment such as a lifter and carry out operations with care to prevent falls or other accidents. Some roll media may weigh about 100 kg (220 lb.). Attempting manual lifting operations that tax your strength may cause physical injury. Also, if dropped, such items may cause unexpected injury, such as crushing of the feet.
- ⚠️ WARNING** Never use media less than 1,220 mm (48 inches) in width. The platen may overheat, resulting in fire or the release of toxic gases.
- ⚠️ CAUTION** Be sure to perform operations as specified by these instructions, and never touch any area not specified in the instructions. Sudden movement of the machine may cause injury.

1. Load the media onto the roll shaft.

Media having an outward curl

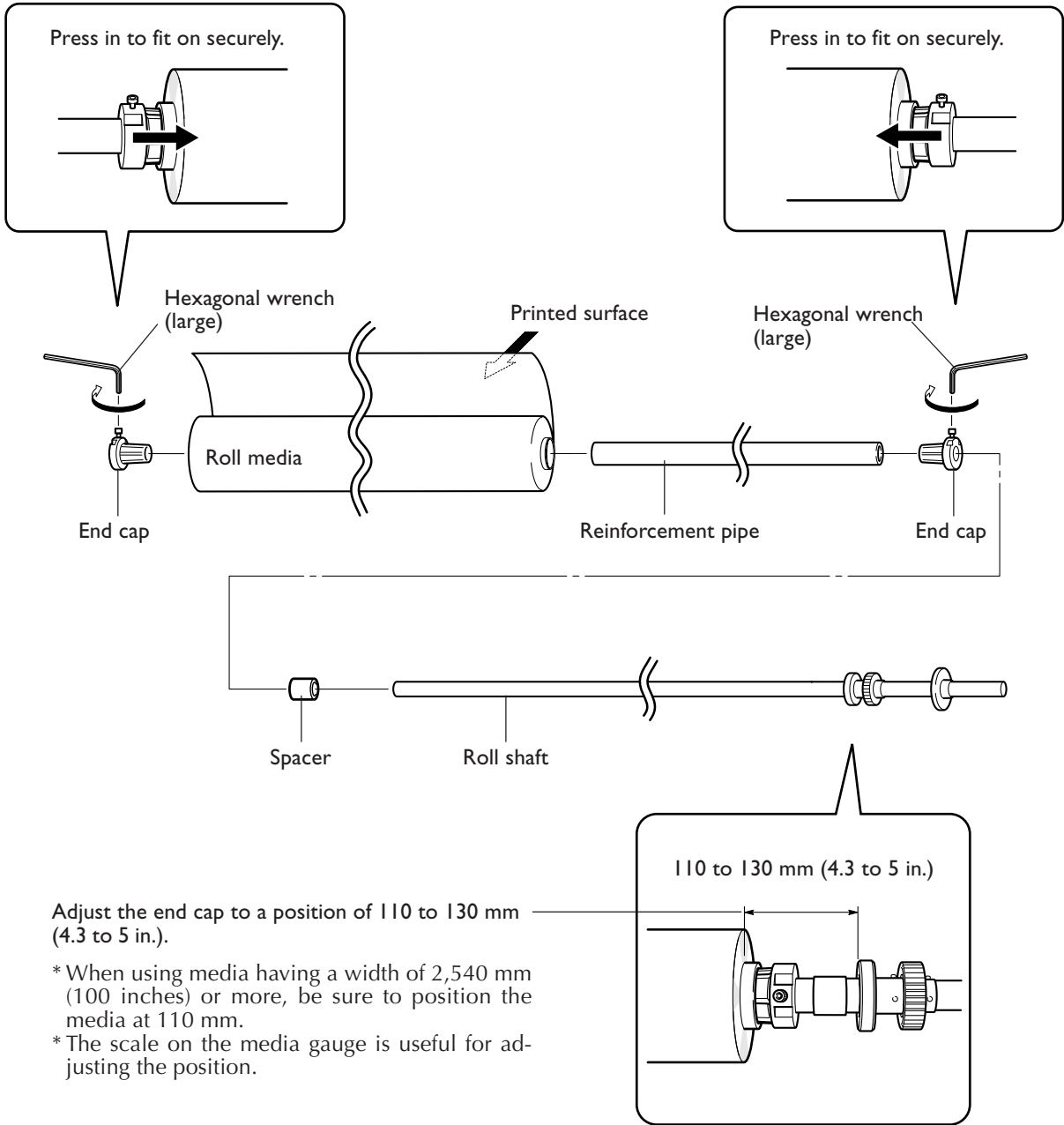

Reinforcement pipe
Use this when loading media that has a width of 1,880 mm (74 inches) or wider. It reduces sagging of the roll media.

End cap Reinforcement pipe Media

■ Media having an inward curl

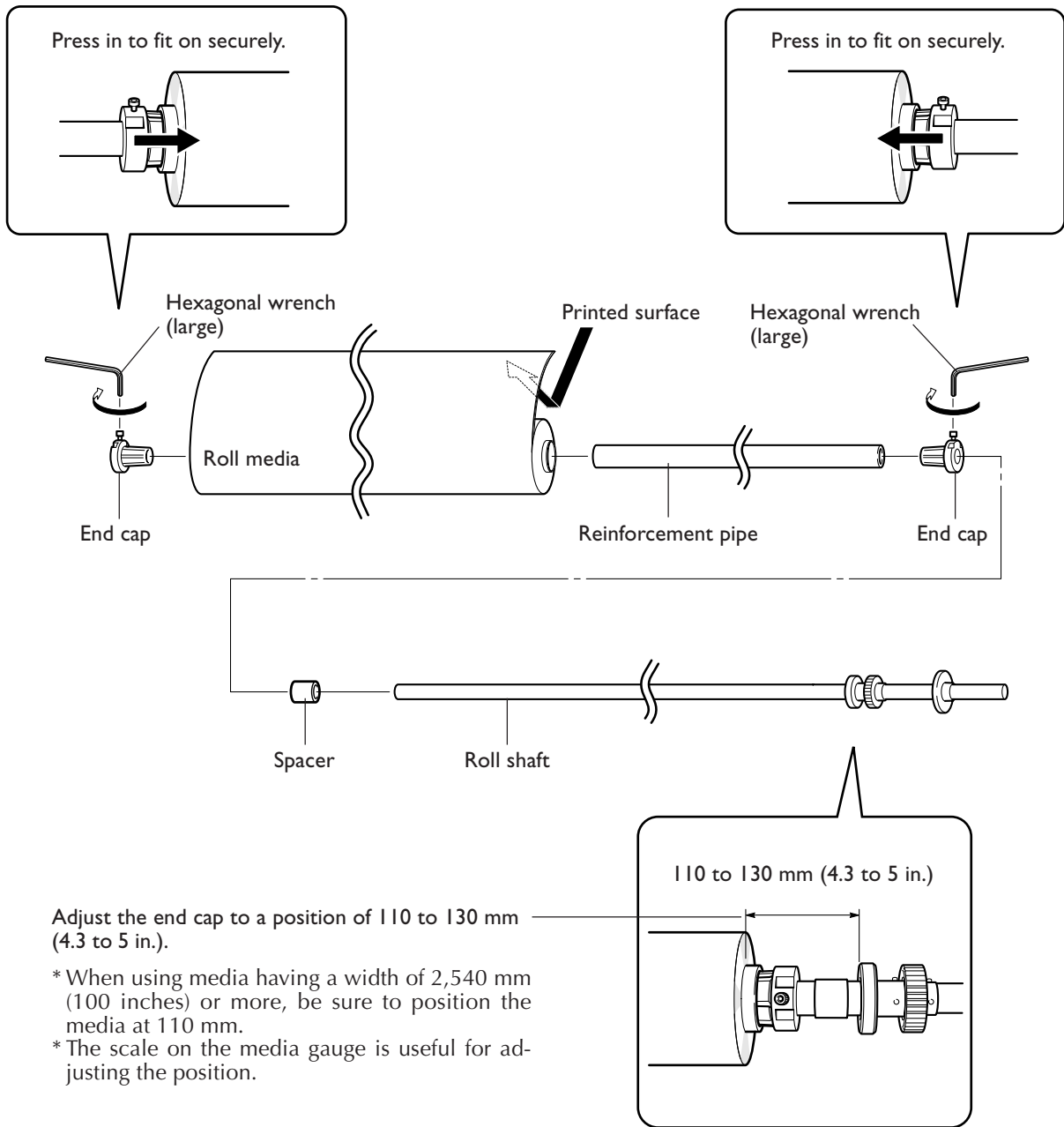

Reinforcement pipe

Use this when loading media that has a width of 1,880 mm (74 inches) or wider. It reduces sagging of the roll media.

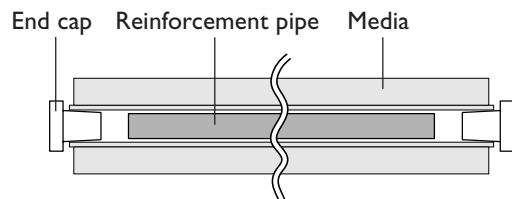

2. Mount the roll shaft in the paper pipe.

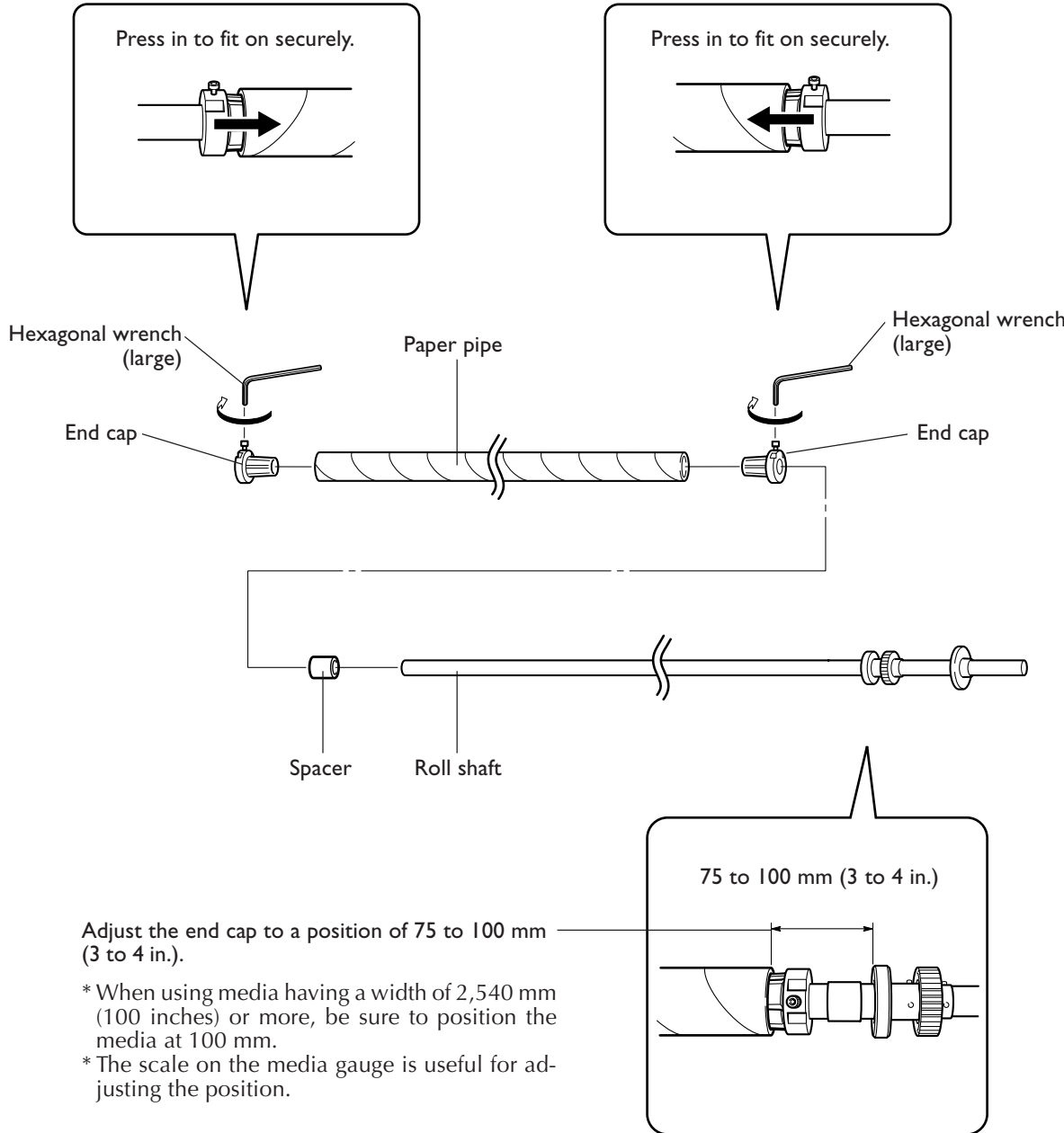

3. Mount the media and paper pipe on the take-up and feed units.

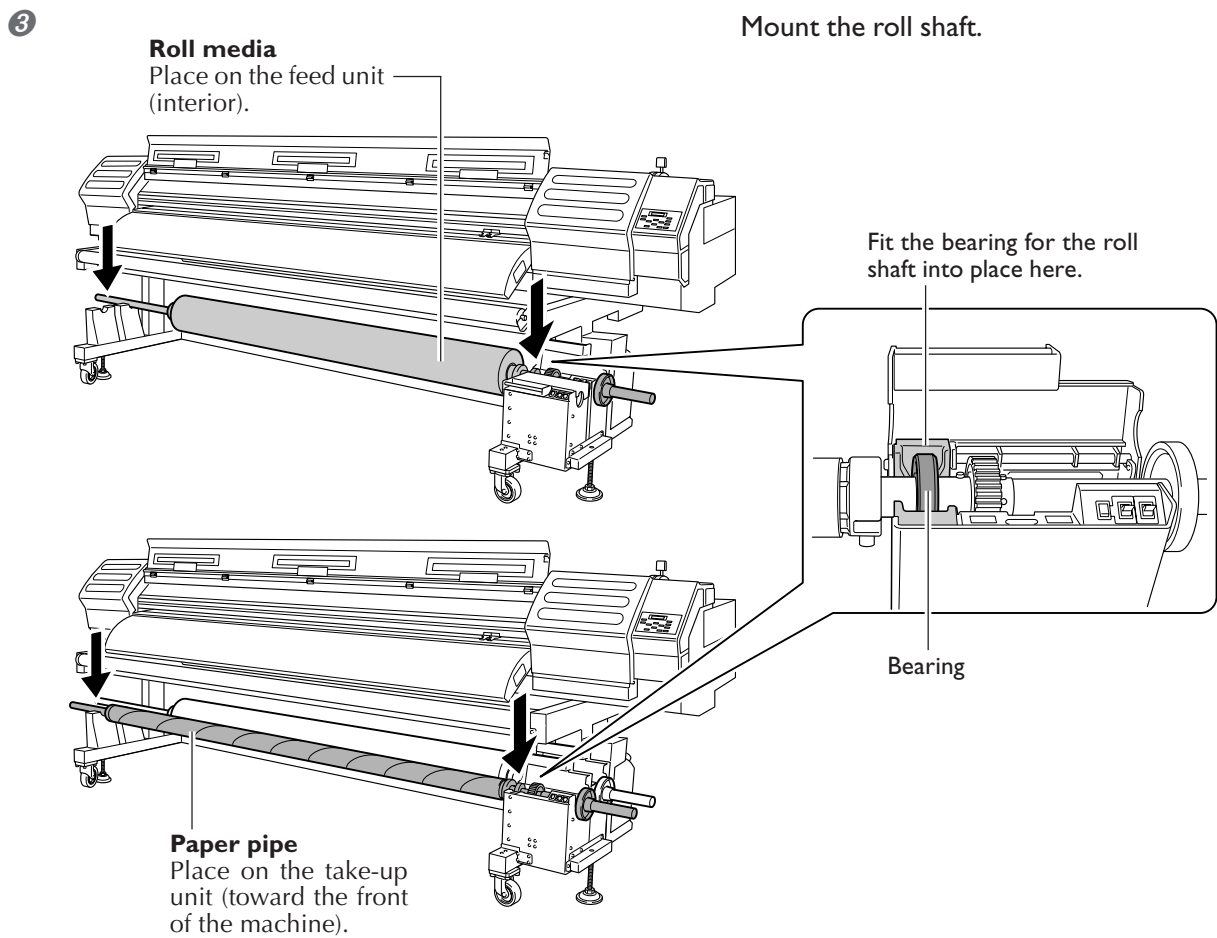
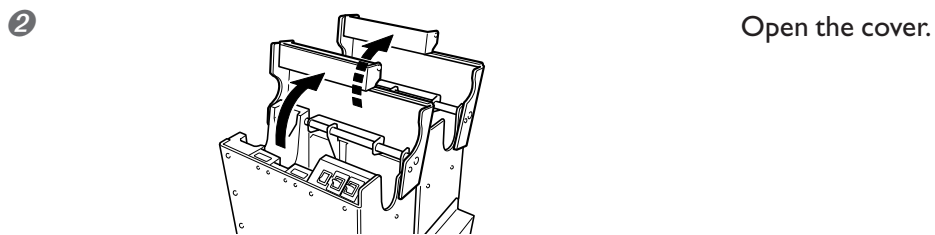
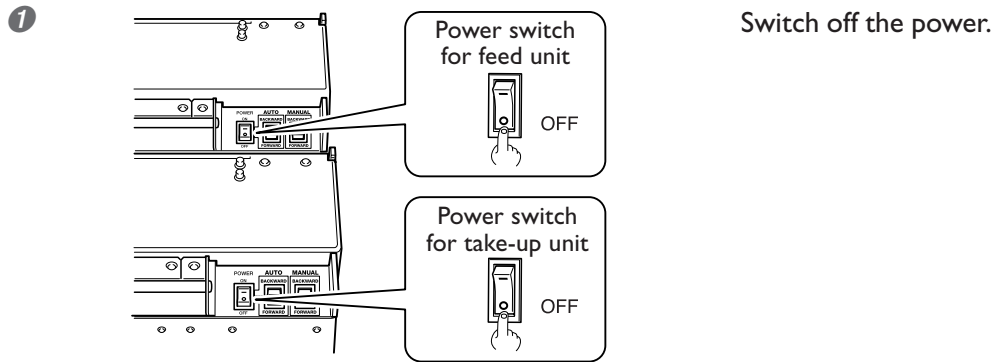

4. Pass the media through the printer and adjust the balance weights.

1 Before you pass the media through, move the balance weights to match the width of the media.

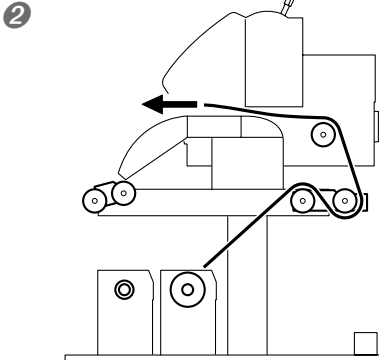
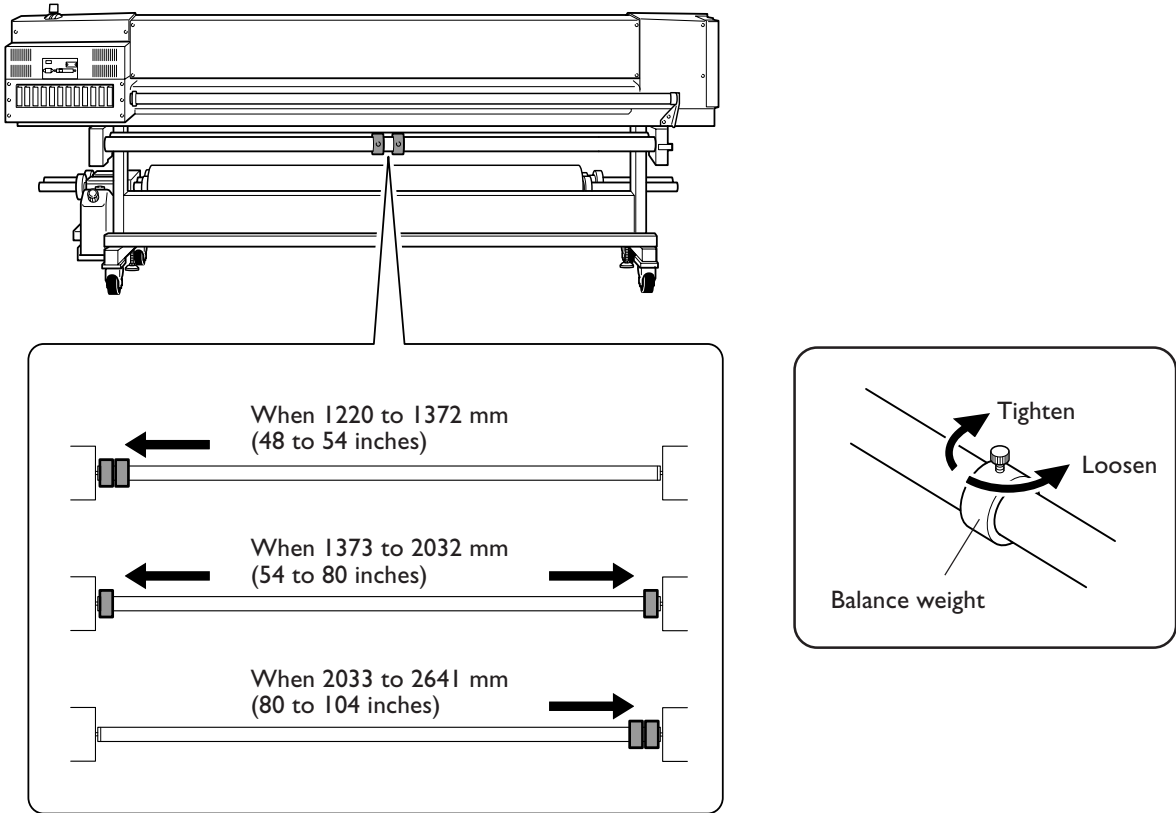

Pass the media through the rollers until its end reaches the platen.
Work from the back of the printer.

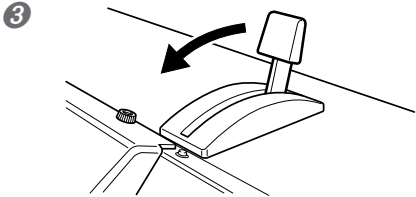

Pull back the loading lever to keep the threaded media from slipping and falling off.

- 4 Adjust the position of the balance weights to match the width of the media.

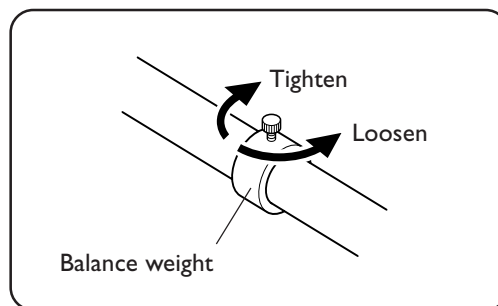
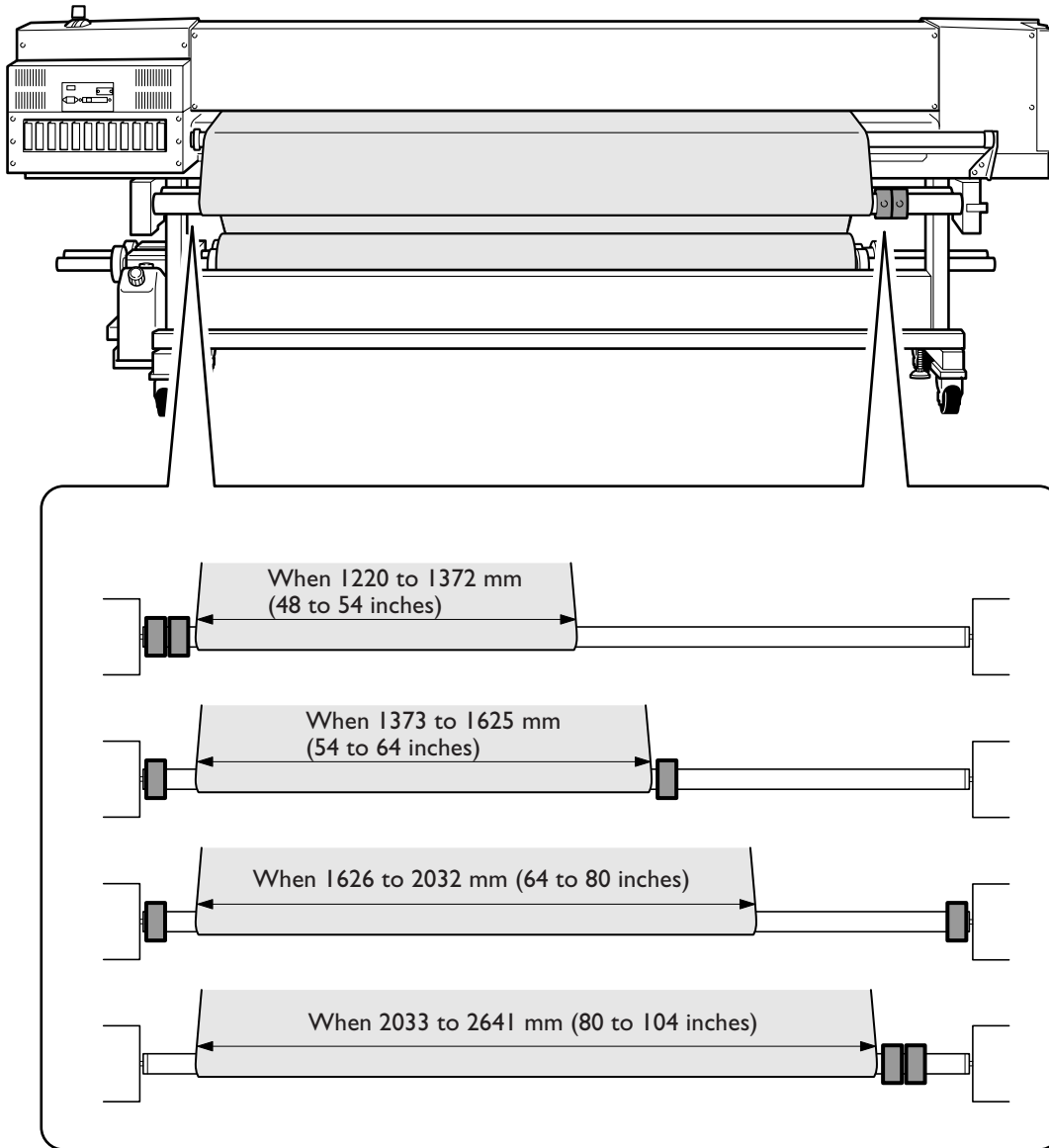

5. Fasten the media to the paper pipe.

①

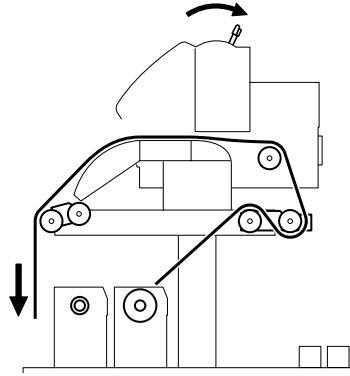

- ① Go to the front of the printer.
- ② While holding down the media by hand to keep it from slipping out of place, flip the loading lever to the rear.
- ③ Pull the media to a position next to the paper pipe.

②

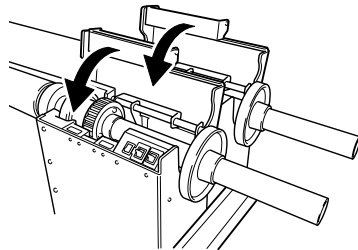

Close the cover.

③

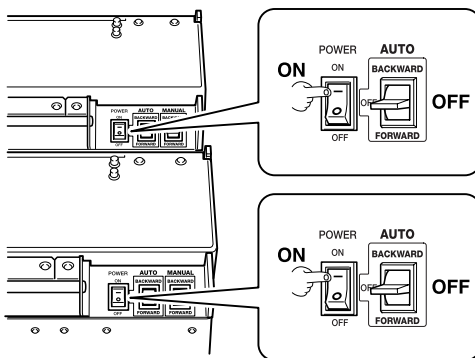

- ① Set the AUTO switch off.
- ② Switch on the power.

④

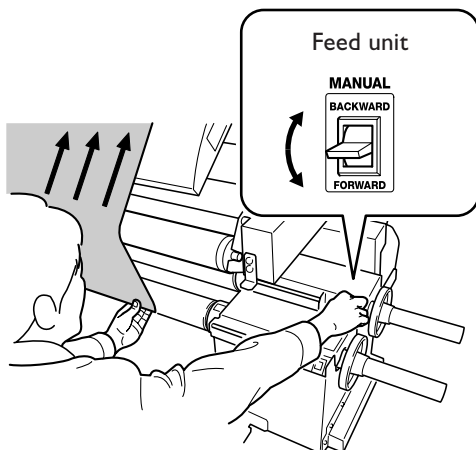

While pulling the media to keep it taut, adjust the position of the end of the media. Position so that the end of the media reaches the paper pipe (that is, so that it reaches a position where it can be taped in place).

- 5 While pulling the media to keep it taut, adjust the position of the end of the media.

Position so that the end of the media reaches the paper pipe (that is, so that it reaches a position where it can be taped in place).

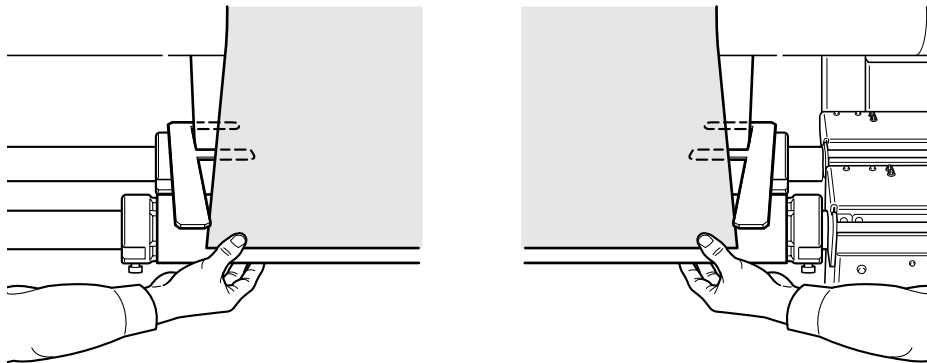
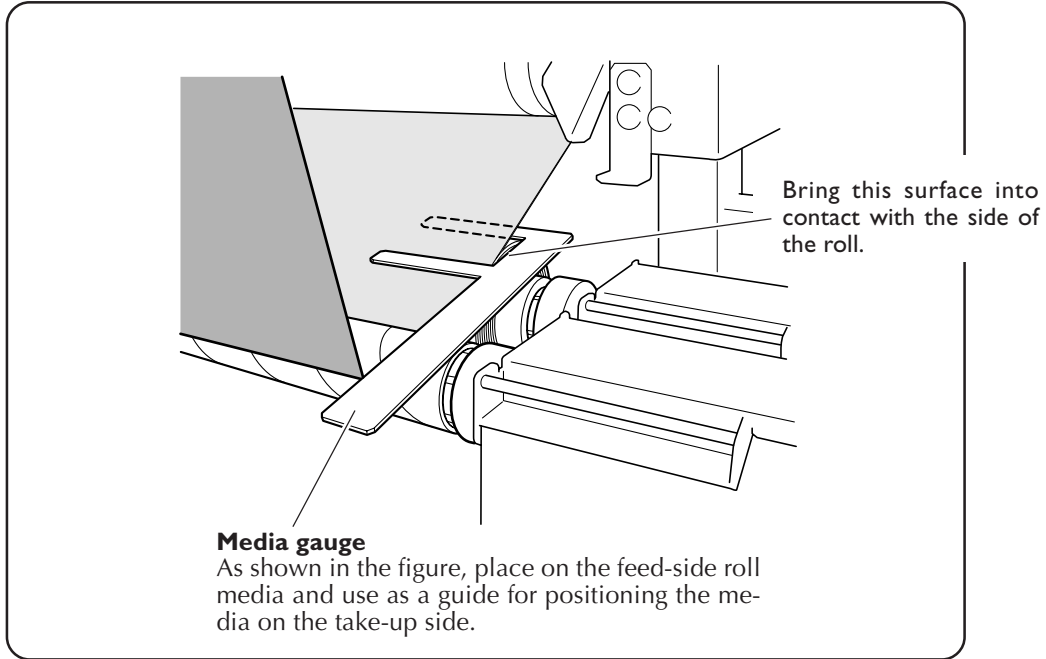

As you position the left and right edges, follow the procedure 6 on the following page to tape the media in place.

- 6 Use adhesive tape to fasten the media securely to the paper pipe. Apply the adhesive tape at intervals of about 20 to 30 cm (10 inches).

■ Take-up with outward curl

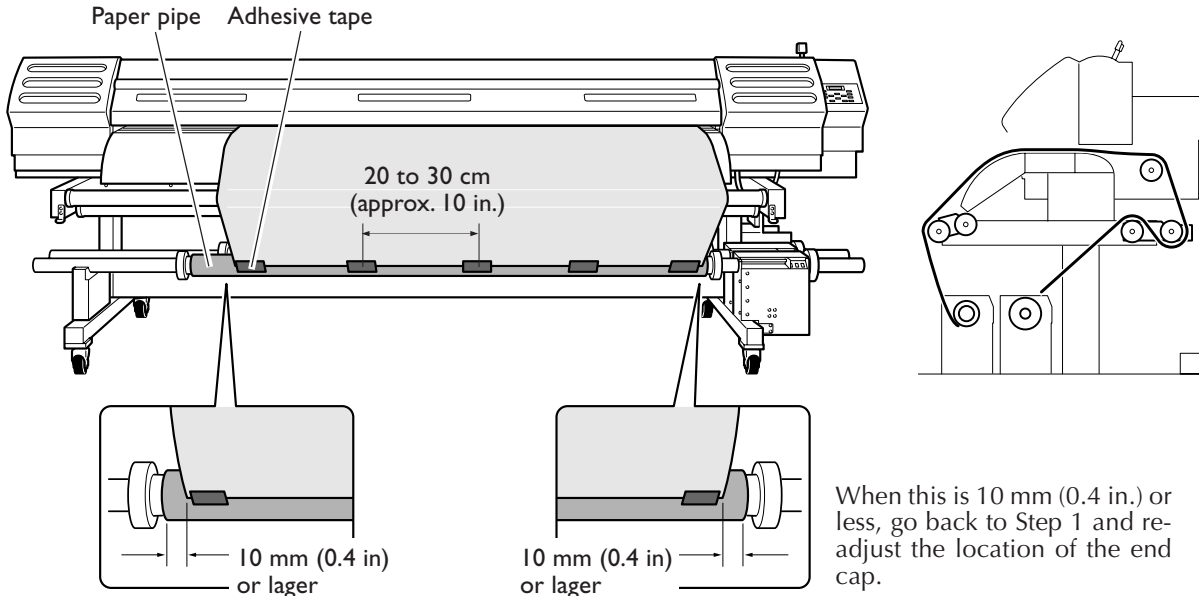

■ Take-up with inward curl

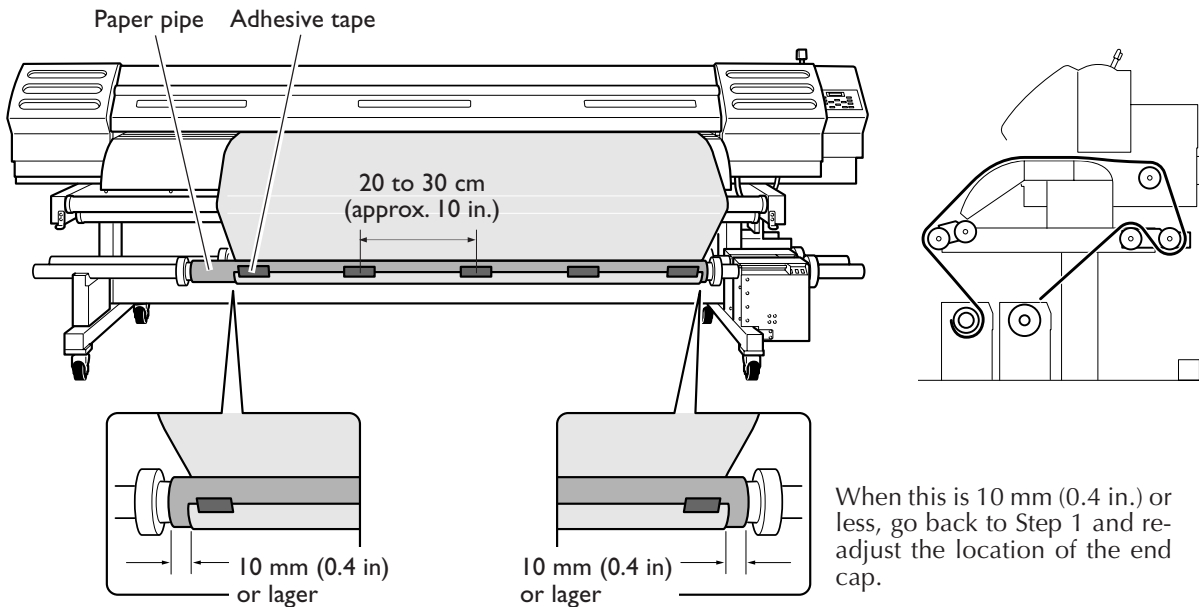

6. Set the orientation for automatic feed and automatic take-up.

- 1 Make the setting for the AUTO switch on the feed unit.

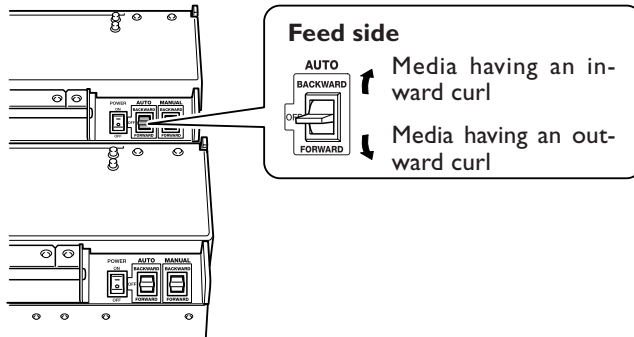

- 2 Operate the MANUAL switch to take up the media and pull it taut. Take up the media for one turn or more.

■ Take-up with outward curl

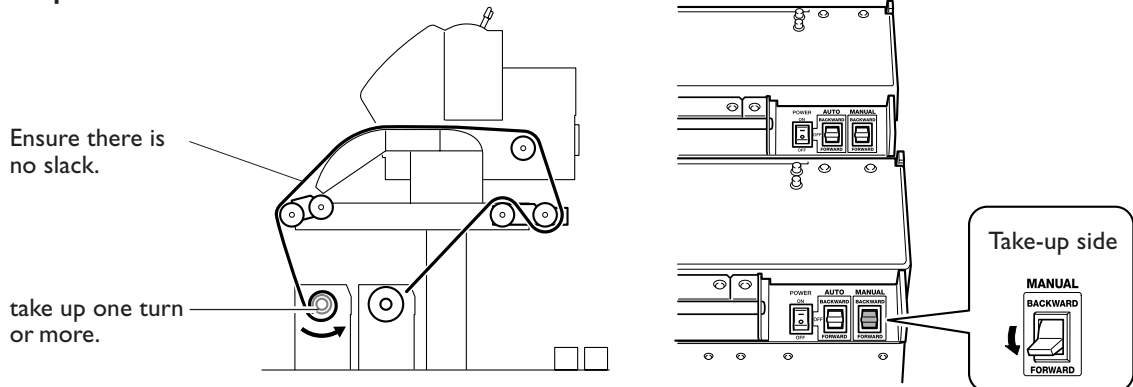

■ Take-up with inward curl

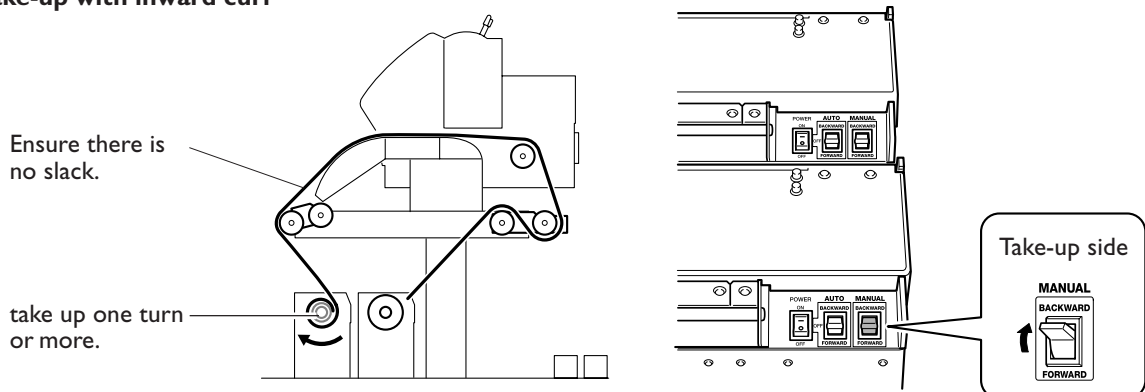

When you begin take-up, take care to ensure that the end of the media does not become rolled or creased.

3 Make the setting for the AUTO switch on the take-up unit.

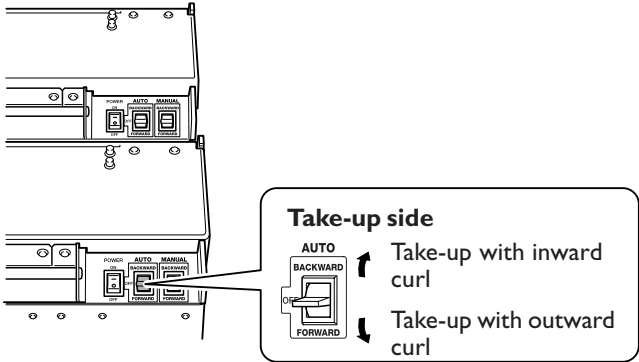

4 Pull back the loading lever to secure the media in place.

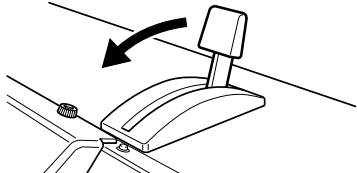

7. Install the media clamps.

The media clamps are magnetic.

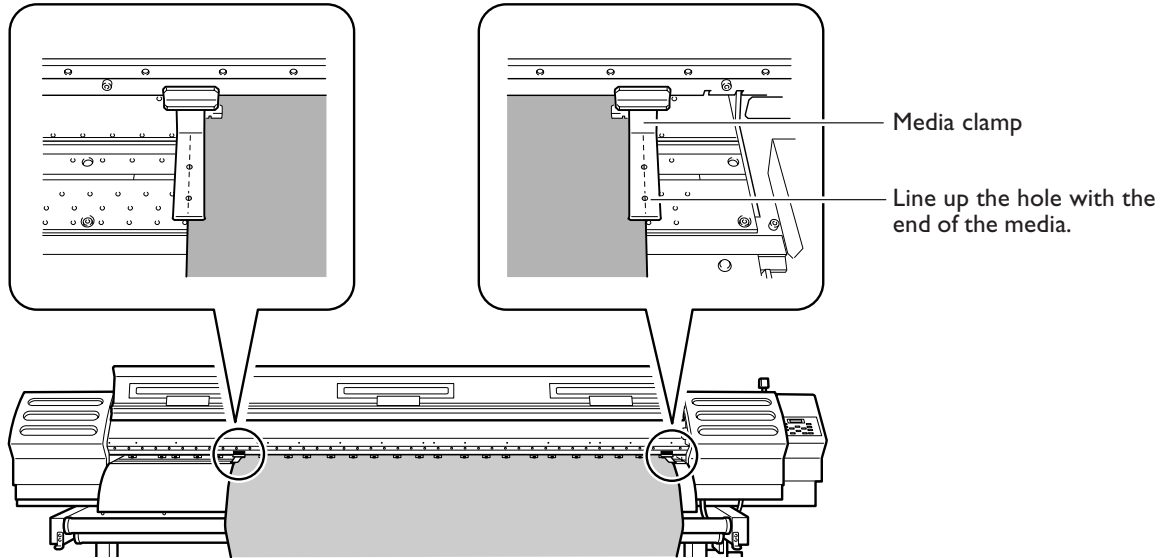

How to install correctly

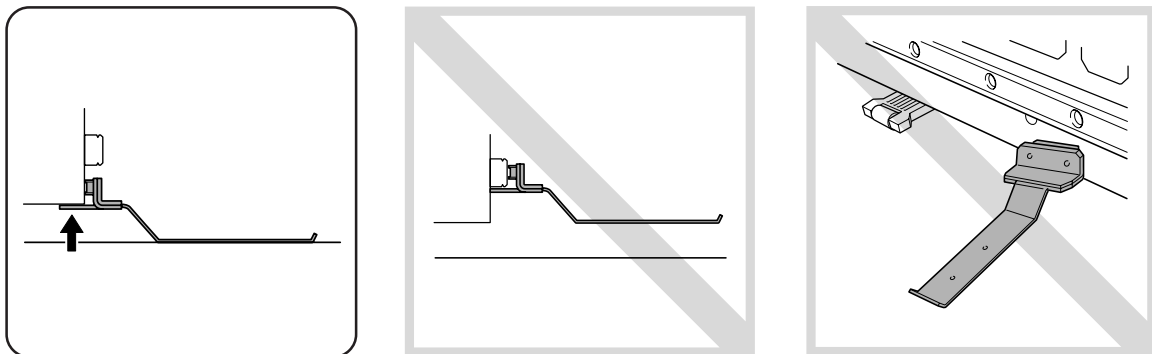

Important Notes on the Media Take-up and Feed Systems

Never attempt any operation that pulls the media with excessive force, like the ones shown below.

- Never operate the MANUAL switch when the loading lever has been pulled back.
- Never use  to feed the media in reverse.

CAUTION

Never needlessly touch loaded media, rollers, or the like.

Sudden movement of the media take-up or feed system may cause fingers, clothing or the like to become caught, resulting in injury.

How to Cut Off Media

⚠ CAUTION The cutter knife used here is sharp and poses a hazard. Carry out operations with caution to avoid injury.

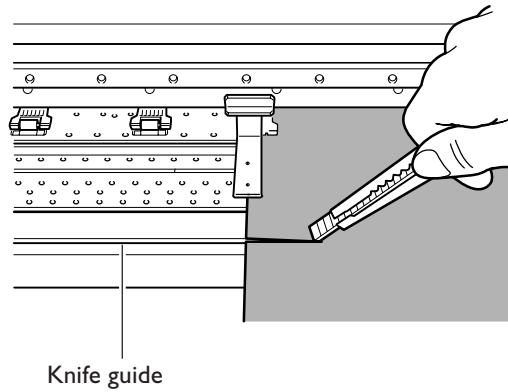

Cut off the media along the knife guide, using a retractable knife or the like.

2-3 Settings of Preheater, Print Heater and Dryer

What Are the Preheater, Print Heater and Dryer?

This machine is equipped with three devices for heating media. You use these mainly to improve ink adhesion and dry the ink. You can adjust the temperature settings to match the type of media and printing speed.

Preheater

This device warms the media before printing.

Print heater

This device is used mainly to improve ink adhesion.

Dryer

You use this to speed up drying of the ink.

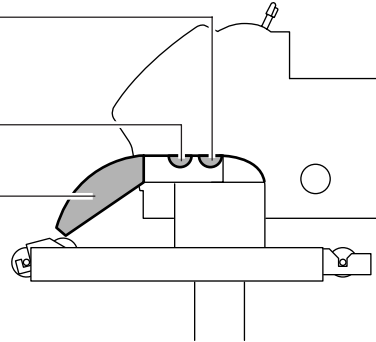

⚠️ WARNING The platen and dryer become hot. Exercise caution to avoid fire or burns.

⚠️ WARNING Never leave media loaded in the machine when printing is not being performed. The continued application of heat at a single location may cause fire or produce toxic gases. When printing is not being performed, switch off the power or remove any loaded media.

⚠️ WARNING Never use media that cannot withstand the heat. Doing so may result in fire or the release of toxic gases, or may degrade the media.

Temperature Settings for the Preheater and Print Heater

Procedure

- ①

PRE	45	45
PRINT	45	45 ←

Press **HEATER CONFIG** .

Use **←** **→** to select the preheater or print heater.

Use **↑** **↓** to make the setting.

Press **ENTER** to enable the setting.

↑ ↑

Preset Actual

temp. temp.

- ②

W 2600 mm
SETUP SHEET

Press **MENU** .

Press **←** to go back to the original screen.

At first, the preheater and preheater do not warm up to the preset temperature. (This is the factory-default setting.) Pressing **SET UP** to make the light come on makes them to warm up to the preset temperature.

Temperature Setting for the Dryer

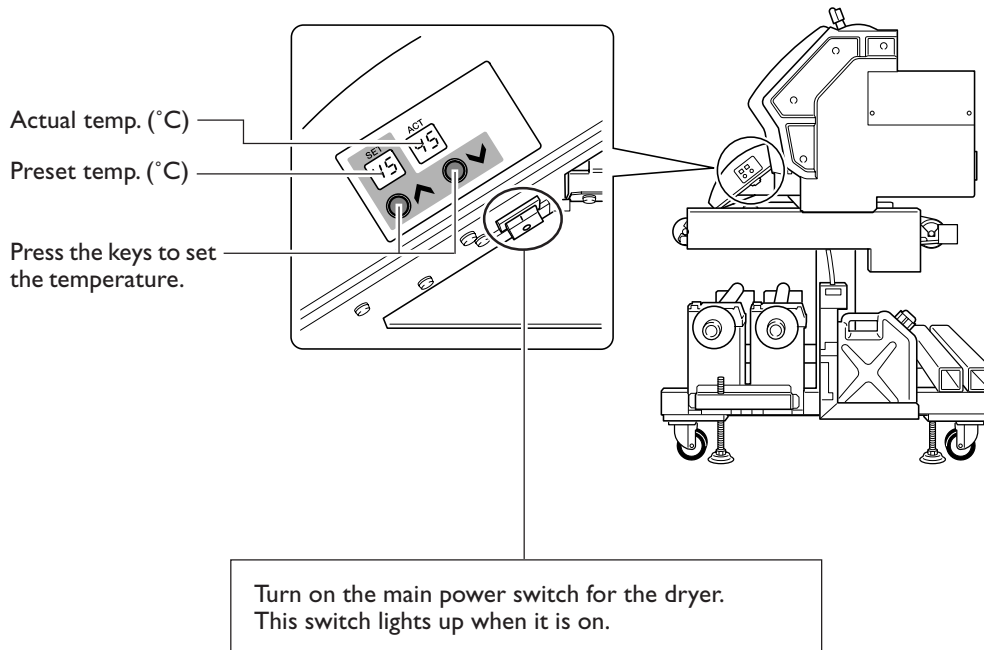

General Guide for the Preset Temperatures

The optimal temperature settings vary according to the type of media, differences in the print mode, and other factors. Use the following as a general guide and adjust accordingly.

General Guide for Adjustment

Preheater

Set this to a temperature that is the same as or lower than the temperature of the print heater.

You use the preheater mainly to heat media gradually. This is because media becomes more likely to shrink or wrinkle if heated suddenly.

Print heater

You use this mainly to improve ink adhesion and inhibit smudging.

If the ink forms lumps or smudges, raise the temperature. Note, however, that a temperature that is too high may degrade the media or cause it to wrinkle.

Dryer

When ink drying is poor, raise the temperature. Note, however, that a temperature that is too high may degrade the media or cause it to wrinkle.

The relationship between the print mode and temperature

If smudging or poor drying occur even after raising the temperature, try using a print mode offering higher image quality. Conversely, when you want to use a faster print mode, raise the temperature.

Amount of ink

When you change the amount of ink using the settings for your RIP program, adjusting this may yield better results. If problems such as smudging persist even after raising the temperature, try reducing the amount of ink.

Examples of Preset Temperatures

Media	Temperature
Type: Scrim banner (PVC) Thickness: 300 to 400 µm (12 to 16 mil)	Preheater: 45°C (112°F) Print heater: 45°C (112°F) Dryer: 50°C (122°F)
Type: Marking film (PVC, with adhesive) Thickness: 60 to 100 µm (2.5 to 4 mil, not including backing paper)	Preheater: 40°C (104°F) Print heater: 40°C (104°F) Dryer: 45°C (112°F)

- These are only rough estimates. Make adjustments to match the media you're using.
- Using the heating devices does not necessarily make it possible to apply ink to every kind of media. Be sure to test in advance.
- Results may vary greatly depending on the print mode and other factors. Make settings suited to the media.
- When suggested settings for temperature, print mode, and other values are given, use the suggested settings.

2-4 Starting Printing

Getting Ready to Receive Data from a Computer

When you have finished loading media and making the temperature settings for the heating devices, then follow the steps below. This procedure enables the machine to receive data from the computer and perform printing.

Procedure

- 1 Close the front cover.
- 2 Press **SET UP** (making the light come on).
- 3 Wait until the **HEATER CONFIG** light stops flashing and stays steadily lit.
- 4 Wait for the dryer to warm up.
- 5 Make sure you are at the top menu.
If you are not at the top menu, press **MENU** , then press **◀** .

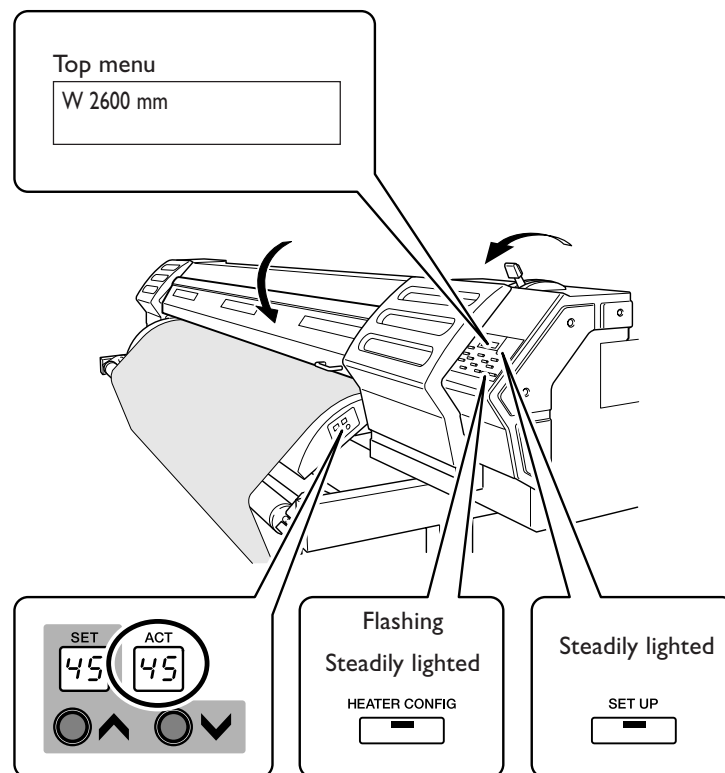

Printing Is Not Possible in These Situations

- The machine does not run when the front cover is open. Also, never open it when printing is in progress. Doing so interrupts printing.
- Data from the computer is not accepted when **SET UP** light is dark.
- **SET UP** light does not come on when media is loaded incorrectly.
- Printing does not start until **HEATER CONFIG** light comes on.
- Data from the computer is not accepted when you are not at the top menu.

Printing Tests and Cleaning

We recommend performing a printing test to check for problems such as dot drop-out before you carry out actual printing. If problems such as dot drop-out are found, clean the print heads.

How to Perform a Printing Test

Hold down for one second or longer.

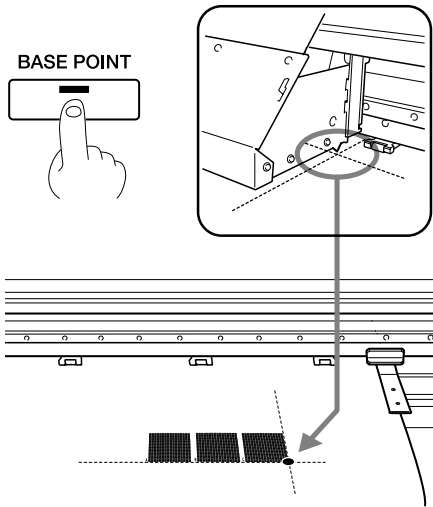
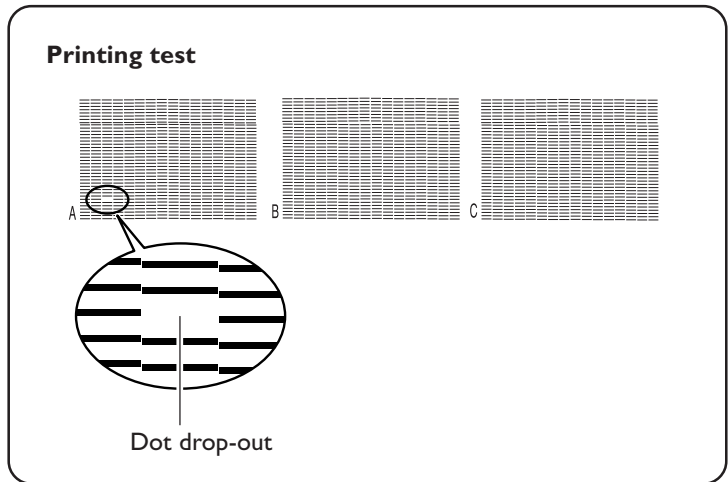
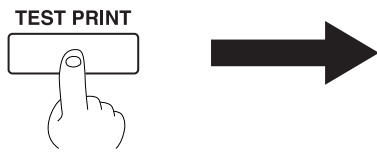

Holding down **TEST PRINT** for one second or longer prints a test pattern.

You can print the test pattern where you want by using **◀** **▶** **▼** to move the print heads, then pressing **BASE POINT**. The front cover may be open during movement, but be sure to close it before you press **TEST PRINT**.

How to Perform Cleaning

Hold down for one second or longer.



Closing the front cover and holding down **CLEANING** for one second or longer performs cleaning for the heads. When the operation ends, press **MENU**, then **◀** to go back to the initial screen.









It may be a good idea to perform a printing test again to make sure the dot drop-out has been corrected. If the problem persists, try performing cleaning a second time. If the problem doesn't go away even after performing cleaning two or three times, then try cleaning using a different method.

☞ p 53 "When Head Cleaning Is Not Effective"

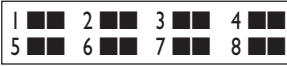
2-5 If Ink Runs Out

Checking for Remaining Ink

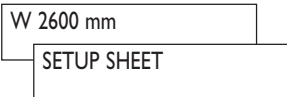
Procedure

-  Press  .
Press  several times.
-  Press  .
-  Press  .
-  Press  .
Press  to go back to the original screen.

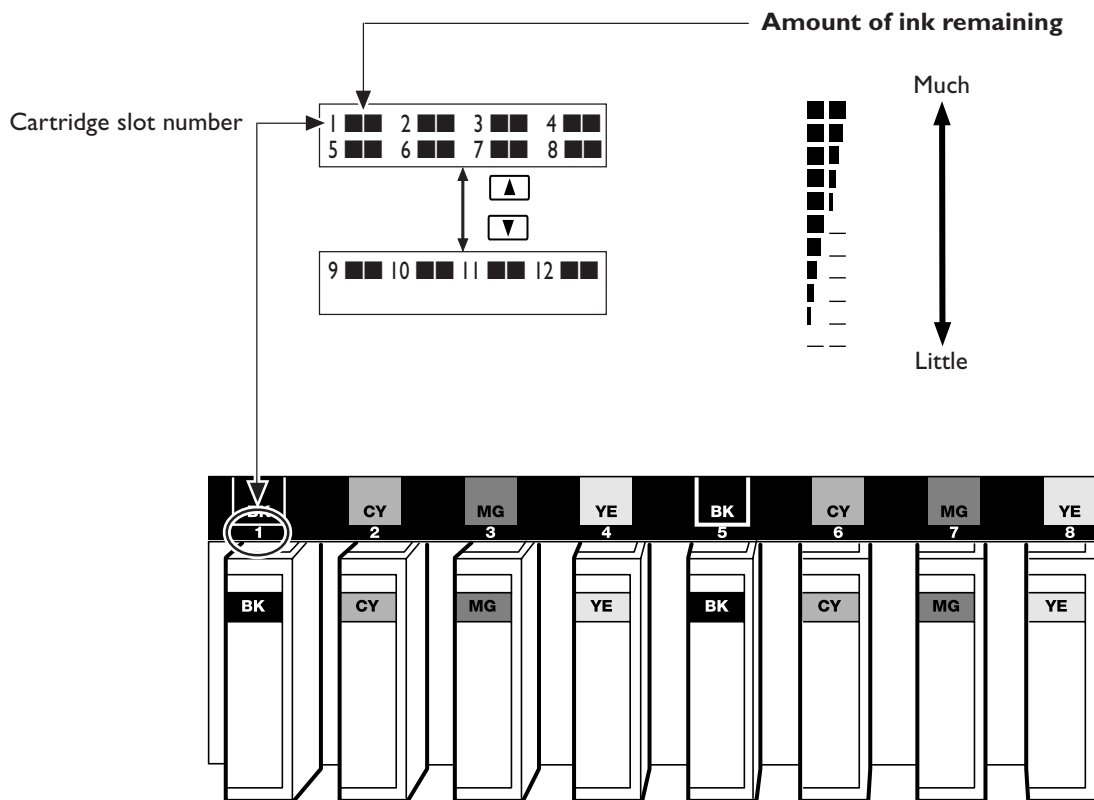

The display shows an approximate guide to the amount of remaining ink, which may differ somewhat from the actual amount remaining. Also, the displayed information may differ greatly from the actual amount remaining if you insert a partly used ink cartridge or change cartridges while the power is off.

If Ink Runs Out

When ink runs out, a warning beep sounds and printing pauses (unless the default settings have been changed). Pull out the empty cartridge and insert a new one. Printing resumes.

Procedure

1

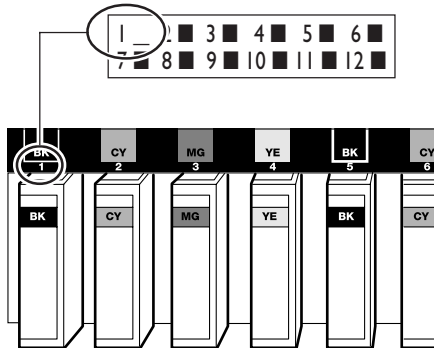

The slot number for the empty cartridge flashes.

2

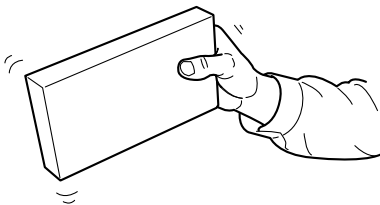

Gently shake the new cartridge.

3

Pull out the empty cartridge and immediately insert the new one.

- Keep the labeled side face up.
- Insert and remove slowly, one at a time.
- Insert firmly, as far as it will go.

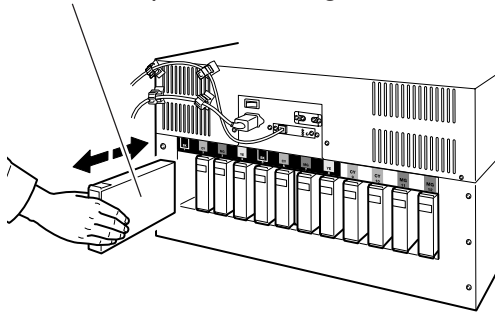

Replace with an item of identical type and color.

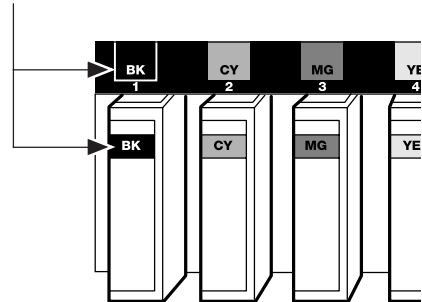

Important Notes on Replacing Cartridges

- Be sure to replace with an item of identical type. Never mix items of different types.
- Never allow the machine to stand with an ink cartridge removed. The print heads may become clogged.
- Never insert or remove a partially used ink cartridge.
- Never remove an ink cartridge suddenly while the printer is in operation.

⚠ WARNING Never place ink, cleaning liquid, or discharged fluid in any of the following locations.

- **Near open flame**
- **In a hot location, such as near a heater or on the machine's platen or dryer**
- **Near bleach, chemicals, explosives, or the like**

Doing so may cause fire.

Chapter 3

Maintenance and

Adjustment

3-I Daily Care and Maintenance

Disposing of Discharged Ink

The drain bottle collects discharged fluid. Dispose of collected material before the bottle becomes full. Switch off the sub power, then remove the bottle, being careful not to spill its contents.

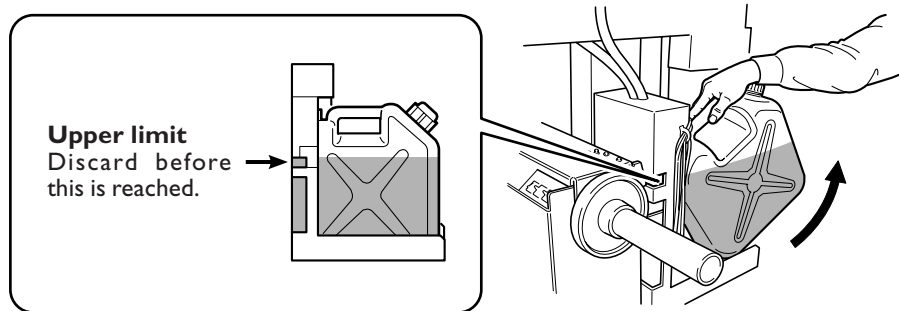

⚠ WARNING Never place ink, cleaning liquid, or discharged fluid in any of the following locations.

- Near open flame
 - In a hot location, such as near a heater or on the machine's platen or dryer
 - Near bleach, chemicals, explosives, or the like
- Doing so may cause fire.

⚠ CAUTION Before carrying out operations, switch off the power.

Discharged fluid flows from the tube when the machine is running. Discharged fluid may get on the hands or spill and soil the floor.

⚠ CAUTION To store discharged fluid temporarily, place it in the included drain bottle or in a durable sealed container such as a metal can or polyethylene tank, and cap tightly. Any spillage or vapor leakage may cause fire, odor, or physical distress.

Dispose of discharged fluid properly, in accordance with the laws in effect in your locale.

Discharged fluid is flammable and contains toxic ingredients. Do not attempt to incinerate discharged fluid or discard it with ordinary trash. Also, do not dispose of it in sewer systems, rivers, or streams. Doing so may have an adverse impact on the environment.

Cleaning

Pinch rollers

Periodically wipe away any grime. Failure to clean properly may result in the transfer of grime to the surface of media.

Grit rollers

Remove buildup of media and other material using a brush. Never use a metal brush.

Clean this area especially well. Any soiling present here may impair detection of media width.

Wipe away any buildup of ink or grime on the media path.

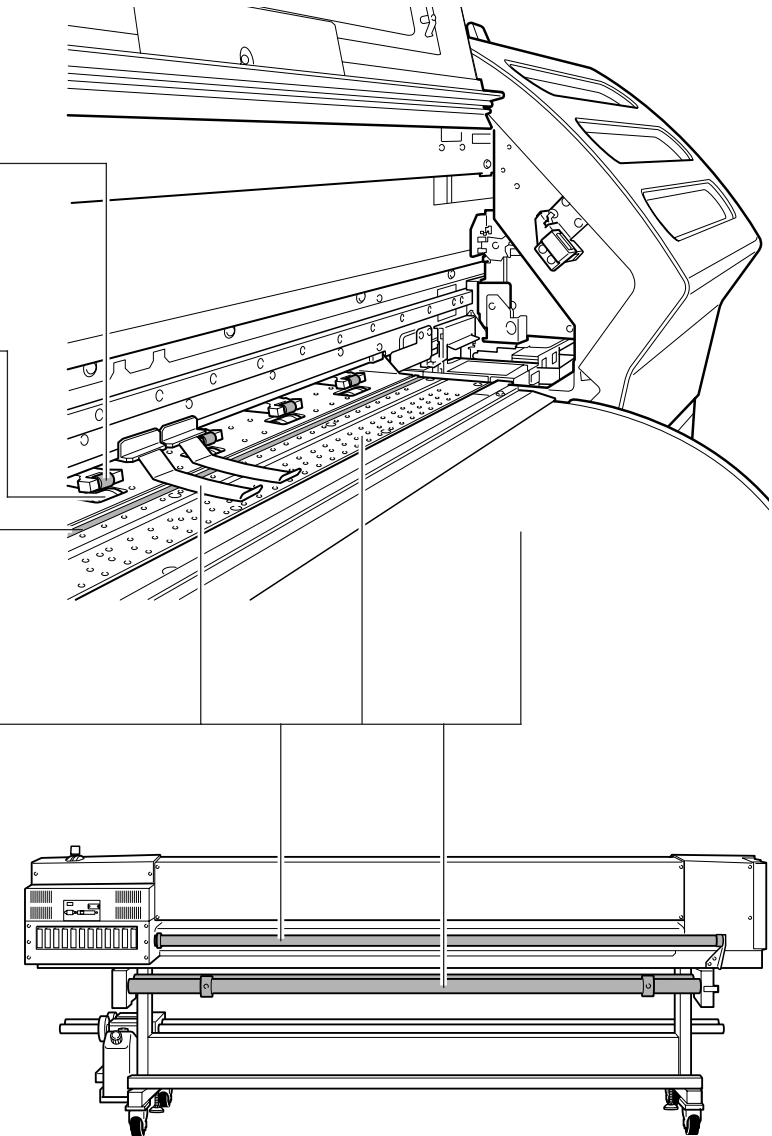

⚠️ WARNING Never use gasoline, alcohol, thinner, or any other flammable material. Doing so may cause fire.

⚠️ CAUTION Before attempting cleaning, switch off the power and wait until the platen and dryer cool (approximately 30 minutes). Sudden movement of the machine may cause injury, or hot components may cause burns.

- This machine is a precision device, and is sensitive to dust and dirt. Perform cleaning on a daily basis.
- Clean by wiping with a cloth moistened by neutral detergent diluted with water then wrung dry.
- Never use a solvent such as thinner or benzene.
- Never attempt to oil or lubricate the machine.

Care and Maintenance of the Print Heads

Daily Care and Maintenance

Use the machine's head-cleaning feature to perform maintenance.

- ☞ p 44 "Printing Tests and Cleaning"
- ☞ p 53 "When Head Cleaning Is Not Effective"

Periodic Care and Maintenance

If problems such as dot drop-out occur frequently and are not corrected by the machine's head-cleaning feature, clean the heads using the cleaning kit. Such cleaning can be effective when carried out periodically, according to the frequency of use.

- ☞ p 55 "Cleaning the Heads Using the Cleaning Kit"

Note: The print heads are components that wear out. Periodic replacement is required, with the frequency of replacement depending on use. Purchase them from your authorized Roland DG Corp. dealer or Roland DG Corp. service center.

3-2 When Head Cleaning Is Not Effective

Performing More Powerful Cleaning

When the problems such as dot drop-out are not cleared up by the cleaning you perform by pressing **CLEANING** (normal cleaning), try the more forceful "medium cleaning" or the even more forceful "powerful cleaning."

Stronger cleaning uses up progressively more ink, and if performed too often it can damage the print heads themselves. Never carry out these cleaning procedures more often than necessary.

1. Choose "medium cleaning" or "powerful cleaning."

- | | |
|---------------|----|
| MENU | ◀▶ |
| HEAD CLEANING | ▶ |

Press **MENU** .
Press **▲** .
- | | |
|---------------|----|
| HEAD CLEANING | ◀▶ |
| ALL MEDIUM | ↕▶ |

or

HEAD CLEANING	◀▶
ALL POWERFUL	↕▶

"Medium": Press **▶** once.
"Powerful": Press **▶** twice.

2. Specify the head group to clean.

- | | |
|---------------|----|
| HEAD CLEANING | ◀▶ |
| A MEDIUM | ↕▶ |
- or
- | | |
|---------------|----|
| HEAD CLEANING | ◀▶ |
| B MEDIUM | ↕▶ |
- or
- | | |
|---------------|----|
| HEAD CLEANING | ◀▶ |
| C MEDIUM | ↕▶ |

Use **▲** **▼** to choose "A," "B," or "C."

Choosing a group uses up less ink than selecting "ALL." Choosing "ALL" performs cleaning for all three groups (A, B, and C).

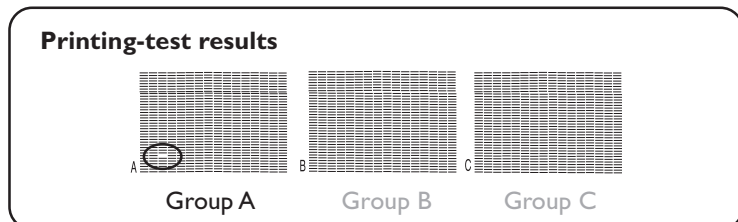

3. Start cleaning.

- | |
|-------------|
| CLEANING... |
|-------------|

Press **ENTER** .
- | |
|-------------|
| W 2600 mm |
| SETUP SHEET |

After cleaning has finished, press **MENU** .
Use **◀** to go back to the original screen.

When Powerful Cleaning Is Not Effective

If problems such as dot drop-out persist even after you have performed powerful cleaning several times, then use the cleaning kit to clean the heads. Such cleaning can be effective when carried out periodically, according to the frequency of use.

☞ p 55 "Cleaning the Heads Using the Cleaning Kit"

3-3 Cleaning the Heads Using the Cleaning Kit

When the Cleaning Kit Becomes Necessary

If problems such as dot drop-out occur frequently and are not corrected by the machine's head-cleaning feature, clean the heads using the cleaning kit. Such cleaning can be effective when carried out periodically, according to the frequency of use.

- If you use up the cleaning kit, purchase a new one from your authorized Roland DG Corp. dealer or Roland DG Corp. service center.
- The print heads are components that wear out. Periodic replacement is required, with the frequency of replacement depending on use. Purchase them from your authorized Roland DG Corp. dealer or Roland DG Corp. service center.

How to Perform Cleaning

Important Notes on This Procedure

- To prevent the heads from drying out, finish this procedure in 30 minutes or less.
- A warning beep sounds after 30 minutes. At this time, stop work, attach the side covers, and press . When the head-protection operation finishes, switch off the power and restart the procedure from the beginning.
- Never use any implement other than the included cleaning stick. Cotton swabs or other lint-producing items may damage the heads.
- Never touch the nozzle surface of the heads.
- Stroke the sponges very gently, applying as little pressure as possible. Never rub, scrape, or crush them.

⚠ CAUTION Be sure to perform operations as specified by these instructions, and never touch any area not specified in the instructions. Sudden movement of the machine may cause injury.

1. Change to the print-head manual-cleaning mode.

1

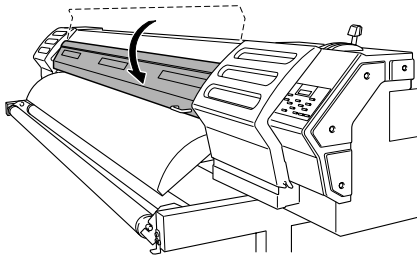

Remove any media from the platen and close the front cover.

2

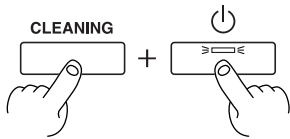

Switch off the sub power.
Hold down **CLEANING** and switch on the sub power.

3



Press to choose [CLEANING].
Press .

4



Preparations are complete when this screen appears.

2. Remove the left and right side covers.

1 Remove the left and right side covers.

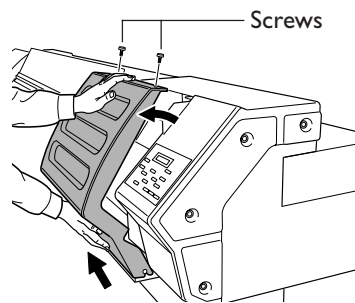
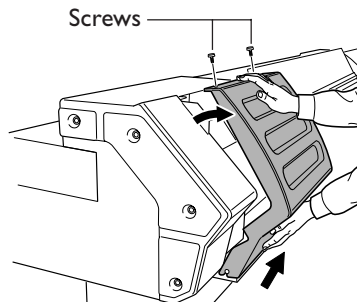

2 Touch the location shown in the figure to discharge any static electricity.

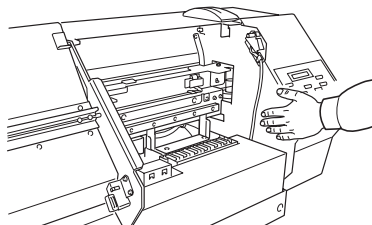

3. Clean using the cleaning stick. Be especially careful to clean away any fibrous dust (lint).

Clean in the sequence shown in the figure below.



Be sure to clean using one of the included cleaning sticks.

 **Never touch the nozzle surface.**
Clean only the metal frame.

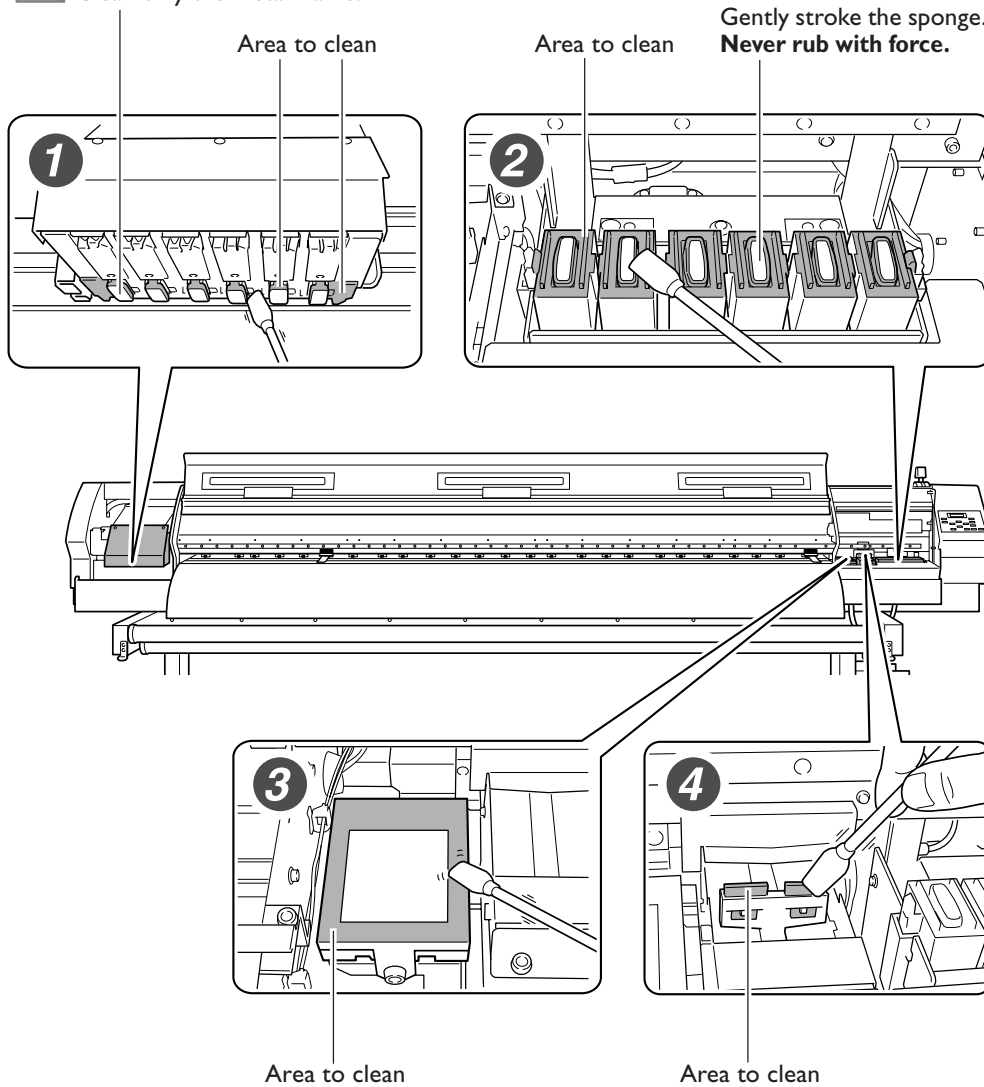

4. Reattach the side covers and quit the manual cleaning mode.

- 1 Attach the left and right side covers.

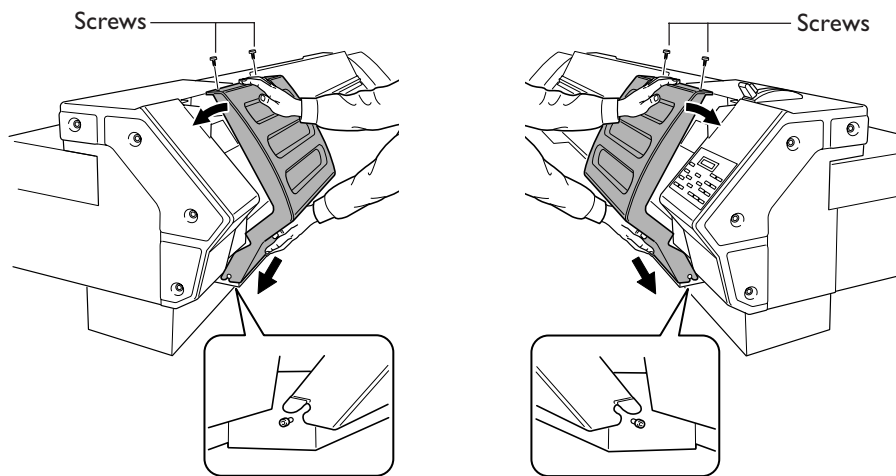

- 2 Press **ENTER** .
After the processing to quit the manual cleaning mode ends, the sub power is switched off.

5. Perform a printing test to verify the results of the procedure.

Perform a printing test to check the results.
Perform automatic cleaning several times as required.

3-4 Replacing Consumable Parts

Replacing the Wipers

TIME FOR
WIPER REPLACE ↵

Press **ENTER**.

The wipers are components that you use when cleaning the print heads. When the screen displays a message like the one shown, it means the item needs to be replaced. Replace with new items.

⚠ CAUTION

Be sure to perform operations as specified by these instructions, and never touch any area not specified in the instructions.

Sudden movement of the machine may cause injury.

1. Enter the wiper replacement mode.

1

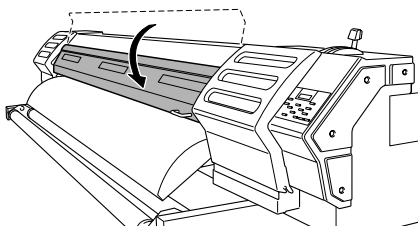

Remove any media from the platen and close the front cover.

2

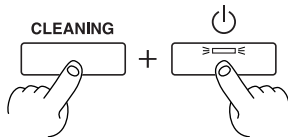

Switch off the sub power.

Hold down **CLEANING** and switch on the sub power.

3



Press **▲** **▼** to choose [WIPER REPLACE].

Press **ENTER**.

4



Preparations are complete when this screen appears.

2. Remove the right side cover.

1

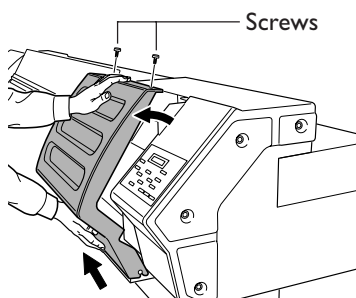

Remove the right side cover.

2

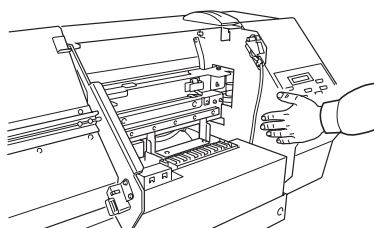

Touch the location shown in the figure to discharge any static electricity.

3. Replace the wipers. Use the included tweezers.

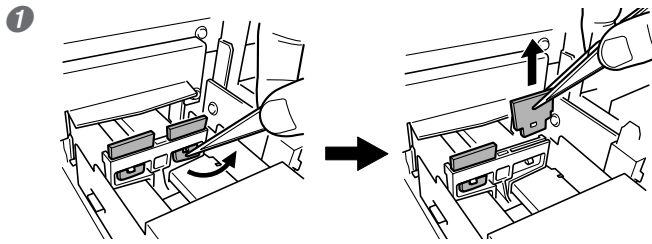

Detach the old wipers.
Detach the hook and pull up and out.

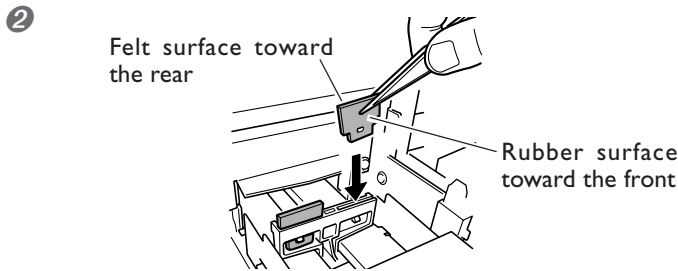

Insert the new wipers.

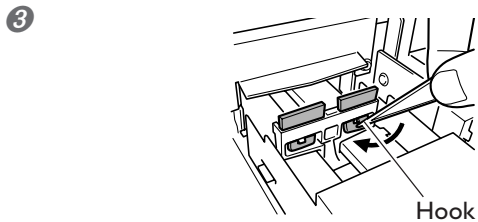

Attach the hook.

4. Reattach the side cover and quit the wiper replacement mode.

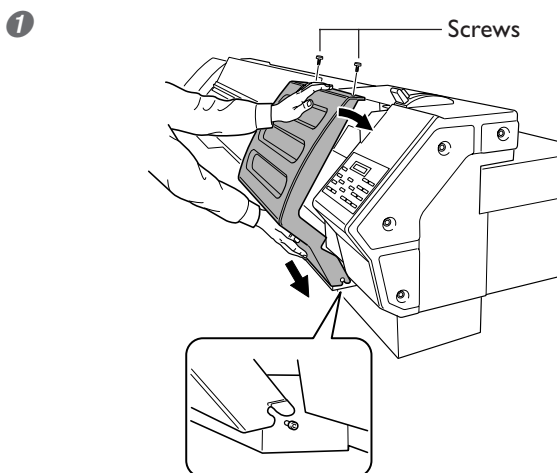

Attach the right side cover.

2 Press **ENTER**.

After the processing to quit the wiper replacement mode ends, the sub power is switched off.

3 Perform a printing test to verify the results of the procedure.

3-5 When Not in Use for a Prolonged Period

Keep Performing Maintenance

Switch On the Power Once a Month

Switch on the sub power once a month. When you turn on the power, the machine automatically performs some operations such as those to keep the print heads from drying out. Allowing the machine to stand completely unused for a prolonged period may damage the print heads, so be sure to switch on the power to perform these automatic operations.

Keep at a Constant Temperature and Relative Humidity

Even when the machine is not in use, keep it at a temperature of 5 to 40°C (41 to 104°F) and a relative humidity of 20 to 80% (with no condensation). Temperatures that are too high may degrade the ink and cause malfunction. Temperatures that are too low may cause the ink to freeze and damage the heads.

Alarm Feature

PRESS THE POWER
KEY TO CLEAN

This feature is to remind you to switch on the sub power once a month. When the machine remains unused for about one month, this screen appears and a warning beep sounds. If this screen appears, switch on the sub power. When maintenance operations finish, switch off the sub power.

This feature operates when the printer's main power is turned on. We recommend leaving on just the main power to the printer even when the machine is to remain out of use for a prolonged period.

Chapter 4

Feature Reference

4-I Pausing or Canceling Printing

Canceling Printing Before It Finishes

Procedure

- 1 Press **PAUSE** .
- 2 Hold down **SET UP** for one second or longer.
- 3 Stop sending printing data from the computer.

Description

PAUSE pauses printing. Pressing **PAUSE** a second time here resumes printing, but a horizontal stripe is produced at the location where printing was stopped. We do not recommend resuming printing.

4-2 Setting the Printing Position and Margins

Shifting the Print-start Position to the Rear

Procedure

Use to move the media.

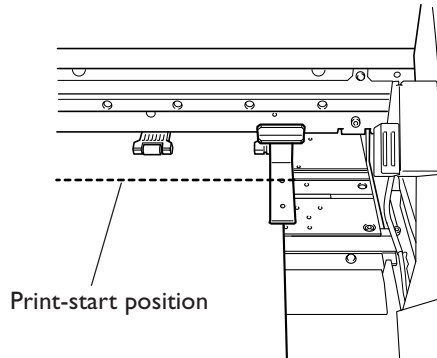

Description

Moving the media using lets you shift the print-start position to the rear. Never use . Doing so may cause the take-up unit to pull the media with undue force, resulting in an error or malfunction.

Shifting the Printing Position to the Left

Procedure

- 1 Use to move the heads.
- 2 Press .
- 3 If the front cover is open, then close it.
- 4 Press .

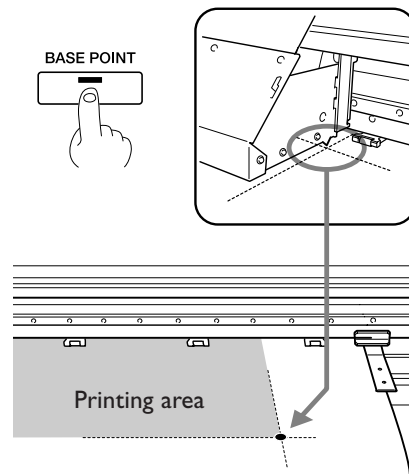

Description

You can accomplish much the same operation described in "Changing the Left and Right Margins" later in this document by using just . Note, however that this setting must be made for each individual page. When the printing of one page finishes, the left-right positioning returns to its default value. When the position has been set, the light comes on and the screen displays the printable width at the set position.

This feature is also available when printing various test patterns, and can help you use media with less waste. Note, however, that the left and right positions are not restored to their defaults for test patterns.

Changing the Left and Right Margins

Procedure

1. Make the setting for the right margin.

- 1 MENU PRINT AREA ◀ ▶ Press .
 ▶ Press .
- 2 RIGHT EDGE SET ◀ ▶ Press twice.
- 3 Use to move the heads.
 Press to enable the setting for the right side.

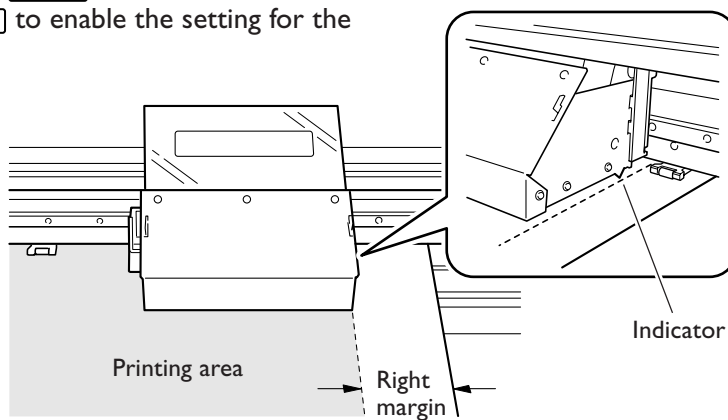

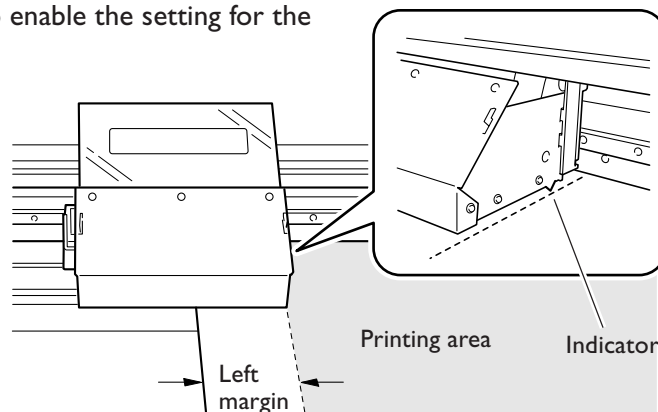

2. Make the setting for the left margin.

- 1 LEFT EDGE SET ◀ ▶ Press .
 ▶ Press .
- 2 Use to move the heads.
 Press to enable the setting for the left side.





3. Go back to the original screen.

① If the front cover is open, then close it.

②  Press  .
Use  to go back to the original screen.

Description

You can perform this operation only when the  light is on. To keep the heads from drying out, the machine forces this operation to end after a certain amount of time has passed. Also, when you want to quit the operation partway through, use  to select [CANCEL], then press  .



Entering the menu moves the head to the position that is currently set, which also lets you confirm the setting later.



This setting is enabled when the  light has been made to go out, such as by removing the loaded media. Redoing setup returns the margins to their default values. Note that certain settings may result in printing in areas where no media is present or on the media clamps.

4-3 Optimizing Printing to Match Media Thickness

Adjusting Head Height to Match Media Thickness





Procedure

1  Press  .
Press  several times.

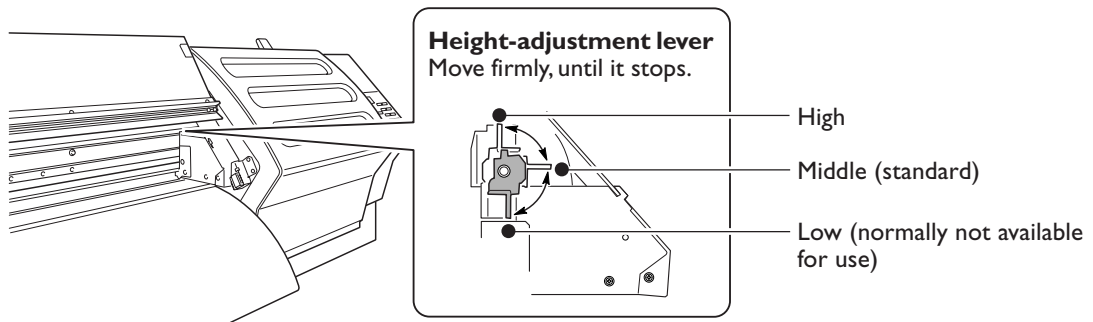
2  Press  .

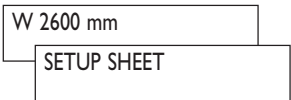
3 Move the lever.



4  Press  .
Press  .
Use  to go back to the original screen.

Description

Depending on the media, media may wrinkle or come loose from the platen during printing, increasing the chance of contact with the print heads. When you are using such media, adjust the head height to "High." Note that the height of the heads cannot be determined by just the thickness of the media.

When the height is set to "Low," the media clamps cannot be used. Except in special cases, the "Low" setting should never be used. Doing so may cause the heads to strike the clamps and become damaged.

Correcting for Misalignment in Bidirectional Printing

Procedure

1. Switch off the power to the take-up unit (leaving the feed unit on).

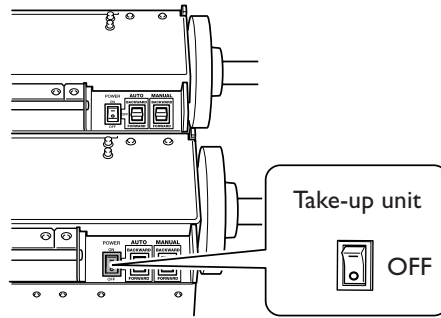

2. Print a test pattern.

- 1** MENU ◀ ▶
 ADJUST BI-DIR ▶

Press **MENU** .
 Press **▼** several times.
- 2** ADJUST BI-DIR ◀ ▶
 TEST PRINT ↵

Press **▶** .
 Press **ENTER** to start printing.

3. Read the correction values from the test pattern.

Test pattern

In this case, choose [-3 1/2]. Choose the value that produces the least misalignment.

NO.1 H6 H5 H4 H3 H2 H1

-30 -29 -28 -6 -5 -4 -3 -2 -1 0 +1 +2 +3 +4 +5 +6 +7 +8 +9 +10

SETTING NO. Current correction value Correction value

Head number

H1: -1	H2: -2	H3: +6
H4: -3 1/2	H5: -2	H6: +8

4. Enter the correction values that you read.

Enter correction values H1 through H6 for each setting number (SETTING NO. 1 through 4), for a total of 24 correction values.

①

ADJUST BI-DIR	◀◆▶
SETTING NO.1	▶

 Press

▼

 .

②

H1	H2	H3	◀◆▶
0	0	0	↵

 Press

▶

 .
Use

◀

▶

 to select.
Use

▲

▼

 to set the correction values.
Press

ENTER

 for finish making the settings for SETTING NO. 1.

③

ADJUST BI-DIR	◀◆▶
SETTING NO.2	▶

 Press

▼

 .

④

H1	H2	H3	◀◆▶
0	0	0	↵

 Press

▶

 .
Use

◀

▶

 to select.
Use

▲

▼

 to set the correction values.
Press

ENTER

 for finish making the settings for SETTING NO. 2.

⑤

ADJUST BI-DIR	◀◆▶
SETTING NO.3	▶

 Press

▼

 .

⑥

H1	H2	H3	◀◆▶
0	0	0	↵

 Press

▶

 .
Use

◀

▶

 to select.
Use

▲

▼

 to set the correction values.
Press

ENTER

 for finish making the settings for SETTING NO. 3.

⑦

ADJUST BI-DIR	◀◆▶
SETTING NO.4	▶

 Press

▼

 .

⑧

H1	H2	H3	◀◆▶
0	0	0	↵

 Press

▶

 .
Use

◀

▶

 to select.
Use

▲

▼

 to set the correction values.
Press

ENTER

 for finish making the settings for SETTING NO. 4.

5. Go back to the original screen.

W 2600mm

Press  .

Press  to go back to the original screen.

Description

The bidirectional-printing mode (in which the heads perform printing during both their outbound pass and return pass) offers the advantage of being fast, but subtle misalignment occurs between the outbound and return passes. The procedure to correct this and eliminate misalignment is bidirectional correction. This misalignment varies according to the head height and the thickness of the media, so we recommend performing correction to match the media you're using.













Redoing correction every time you change the media is extremely troublesome. You can take correction values that you have acquired and save them in the machine's memory for easy access whenever they are needed.

☞ p 72 "Saving Bidirectional Correction Values"

☞ p 72 "Loading Bidirectional Correction Values"

Saving Bidirectional Correction Values

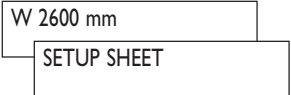
Procedure













- 1  Press  .
Press  several times.
- 2  Press  .
Press  several times.
- 3  Press  .
Use   to select a presetting number.
Press  to save.
- 4  Press  .
Press  to go back to the original screen.

Description

This saves the current correction values in memory. You can a total of eight groups of settings in memories 1 through 8. Overwriting a memory deletes any old correction values it contains.

Loading Bidirectional Correction Values

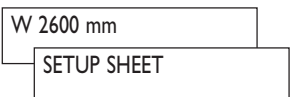
Procedure

- 1  Press  .
Press  several times.
- 2  Press  .
Press  several times.
- 3  Press  .
Use   to select a presetting number.
Press  to load.
- 4  Press  .
Press  to go back to the original screen.

Description

This loads correction values saved in memory. You can select any memory from 1 to 8. Note that loading values from memory erases any correction values that have not been saved.

Performing Feed Correction to Alleviate Horizontal Bands and the Like

Procedure

1. Print a test pattern.

- ①

MENU	◀◆
CALIBRATION	▶

 Press

MENU

 .
Press

▼

 several times.
- ②

CALIBRATION	◀◆
TEST PRINT	▶

 Press

▶

 .
Press

ENTER

 to start printing.

2. Check the test pattern you printed.

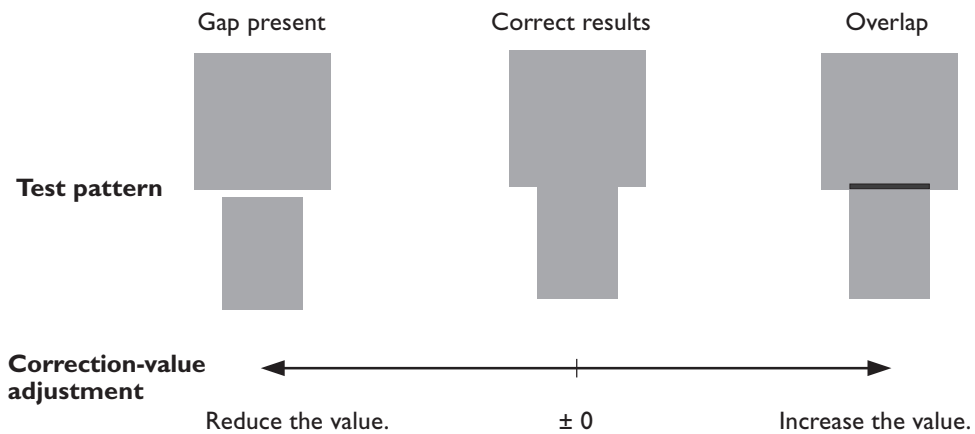

3. Enter the correction value.

- | | |
|---------|----|
| SETTING | ◀◆ |
| 0.00% | ▶ |

 Press

▼

 .
Press

▶

 .
Use

▲

▼

 to make the setting for the correction value.
Press

ENTER

 to enable the setting.

4. Go back to the original screen.

- | |
|----------|
| W 2600mm |
|----------|

 Press

MENU

 .
Press

◀

 to go back to the original screen.

4-3 Optimizing Printing to Match Media Thickness

Description

The movement transfer of media experiences subtle changes due to the thickness of the media and the temperature of the heating devices. When the movement distance becomes discrepant, horizontal stripes are more likely to occur during printing. We recommend performing correction to match the media you're using and the heating devices. Repeat the process of printing a test pattern and entering a correction value a number of times to find the optimize value.

Printing this test pattern using parameters identical to those for actual printing. Also, using material such as media scraps that have passed through the printer may not yield correct results.

Note, however, that you can also make this setting on the computer (by, for example, choosing the media type in the RIP program you are using). Use this feature when you want to make the setting on the printer, without changing any settings on the computer. When you have made the setting on the computer, the computer's setting is used and the printer's setting is ignored.

Default Setting



[CALIBRATION]: 0.00%

4-4 Accommodating Various Kinds of Media

Using Transparent Media

Procedure

1. Set the media type to "transparent."

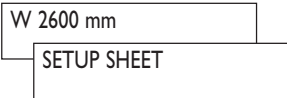
-  Press **MENU** .
-  Press **▶** .
Use **▲** **▼** to select [CLEAR].
Press **ENTER** to enable the setting.
-  Press **MENU** .
Press **◀** to go back to the original screen.

2. Use the [PRINT AREA] menu to make the settings for the left and right margins.

☞ p 66 "Changing the Left and Right Margins"

Description



The media width can be sensed automatically for opaque media, but not for transparent media. This makes it necessary to make the setting manually. Ink may be sprayed onto locations where no media is present if the left and right margins are not set, so be sure to make these settings.

Default Setting

[SHEET TYPE]: OPAQUE

Printing Hard-to-dry Media

Procedure

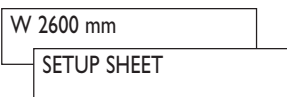
-  Press **MENU** .
Press **▼** several times.
-  Press **▶** .
Use **▲** **▼** to set the value.
Press **ENTER** to enable the setting.
-  Press **MENU** .
Press **◀** to go back to the original screen.

Description

You use this when ink dries poorly even when the dryer is used. Larger values produce progressively slower movement of the media, enabling you to extend the drying time accordingly. Printing time takes correspondingly longer.











You can also make this setting on the computer. When you have made the setting on the computer, the computer's setting is used and the printer's setting is ignored.

Default Setting

[SCAN INTERVAL]: OFF

Speeding Up Printing for Narrow Media

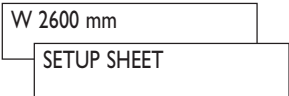
Procedure

- 1**  Press  .
Press  several times.
- 2**  Press  .
Use   to select [MEDIA] or [OFF].
Press  to enable the setting.
- 3**  Press  .
Press  to go back to the original screen.

Description

Reducing the width of head movement to the minimum required width speeds up printing. This is effective mainly when you use media of narrow width. Because the media moves more quickly, the effectiveness of the heating devices also changes. It may be necessary to change the preset temperatures.

"MEDIA" matches the range of head movement to the width of the media. The parameters for the heating devices change according to the media width.

"OFF" matches the range of head movement to the printing data. Movement is limited to the minimum amount necessary, and this can be expected to yield the fastest printing. Note, however, that because the speed of media movement is no longer constant, colors may be uneven.









"FULL" makes the speed of media movement constant at all times.

Default Setting

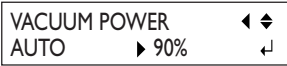
[FULL WIDTH S]: FULL

Preventing Media from Coming Loose

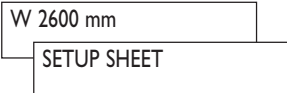
Procedure

- 1  Press  .
Press  several times.
- 2  Press  .
Use   to set the value.
Press  to enable the setting.
- 3  Press  .
Press  to go back to the original screen.

Description

The platen uses suction to grip the media and keep it stable. When media comes loose from the platen because it is warped or wrinkled, increasing the suction force may help correct the problem. Conversely, when the media is flimsy and cannot move smoothly, reducing the suction force may help. When set to [AUTO], the suction force is automatically adjusted to the optimal level for the media width.











You can also make this setting on the computer. When you have made the setting on the computer, the computer's setting is used and the printer's setting is ignored.

Default Setting

[VACUUM POWER]: AUTO

Keeping Media from Being Soiled by Ink Drips

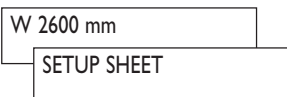
Procedure

- 1  Press  .
Press  several times.
- 2  Press  .
Use   to select [ENABLE].
Press  to enable the setting.
- 3  Press  .
Press  to go back to the original screen.

Description

Ink tends to collect on the surface of the heads when you use media prone to build up a static charge, when the ambient temperature is low, and at other such times. Under some conditions, this ink may be transferred to the media. Use this feature at such times. The ink buildup is removed as printing is performed.

Using this feature results in longer printing times. Because printing is paused, colors may also be uneven.



Default Setting

[PERIODIC CL.]: DISABLE

4-5 Changing How the Printer Operates

Determining What Happens When Ink Runs Out

Procedure

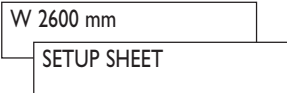
-  Press **MENU** .
Press **▼** several times.
-  Press **▶** twice.
Use **▲** **▼** to make the setting.
Press **ENTER** to enable the setting.
-  Press **MENU** .
Press **◀** to go back to the original screen.

Description



This lets you change, according to your purpose, the operation that takes place when an ink cartridge is empty. [STOP] immediately pauses operation when a cartridge becomes empty. Because pausing printing in progress may make colors uneven, it is best to ensure a sufficient amount of remaining ink before you begin printing. [CONT.] (continue) is a mode in which operation is not automatically stopped. When a cartridge becomes empty, a warning beep sounds, but printing does not stop. (However, operation stops when printing of the current page ends.) To replace the cartridge, you must either wait until printing ends or press **PAUSE** to pause printing. Note that operation does not stop even if ink runs out completely.

Default Setting

[EMPTY MODE]: STOP

Setting the Interval until Activation of the Sleep Mode

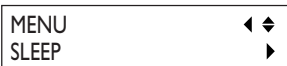
Procedure

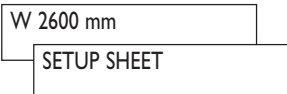











-  Press **MENU** .
Press **▲** several times.
-  Press **▶** twice.
Use **▲** **▼** to make the setting.
Press **ENTER** to enable the setting.
-  Press **MENU** .
Press **◀** to go back to the original screen.

Default Setting

[INTERVAL]: 30MIN

Deactivating the Sleep Mode

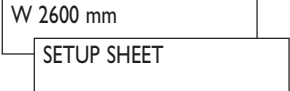
Procedure











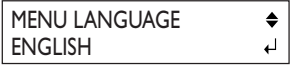

- 1  Press  .
Press  several times.
- 2  Press  .
Press  .
Press  .
Use   to select [DISABLE].
Press  to enable the setting.
- 3  Press  .
Press  to go back to the original screen.

Default Setting

[SETTING]: ENABLE

Changing the Menu Language and the Units of Measurement

Procedure

- 1  Hold down  and switch on the sub power.
Use   to select the display (menu) language.
- 2  Press  .
Use   to select the measurement unit for length.
- 3  Press  .
Use   to select to the measurement unit for temperature.
Press  .

Description

This sets the language and units of measurement displayed on the printer's screen. However, the unit of measurement for dryer temperature is fixed at "°C" and cannot be changed.

Default Setting

[LANGUAGE]: ENGLISH

[LENGTH UNIT]: mm

[TEMP. UNIT]: °C

Returning All Settings to Their Initial Values

Procedure



Press **MENU** .
 Press **▲** several times.
 Press **ENTER** to execute.

Printing a System Report

Procedure



Press **MENU** .
 Press **▲** several times.
 Press **ENTER** to start printing.

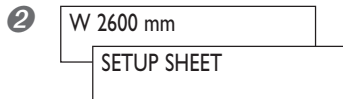

Press **MENU** .
 Press **◀** to go back to the original screen.











Description

This printings system information, including a list of setting values.

4-6 Changing How the Preheater, Print Heater and Dryer Operate

Switching the Dryer On and Off

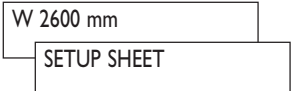
Procedure

-  Press  .
Press  several times.
-  Press  .
Use   to make the setting.
Press  to enable the setting.
-  Press  .
Press  to go back to the original screen.

Description

To operate the dryer, you must switch on both the main power switch for the printer and the main power switch for the dryer, and also enable this menu item.







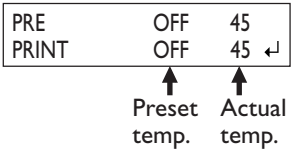

You can also make this setting on the computer. When you have made the setting on the computer, the computer's setting is used and the printer's setting is ignored.

Default Setting

[DRYER]: ON

Switching Off the Preheater and Print Heater

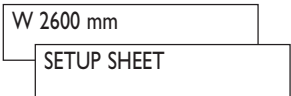
Procedure

-  Press  .
Use   to select the preheater or print heater.
Press  several times to select [OFF].
Press  to enable the setting.
-  Press  .
Press  to go back to the original screen.

Description

This menu is used to make the temperature settings for the preheater and print heater, and you can also use it to turn these off. When set to [OFF], the preheater and print heater do not operate at all.

Note, however, that you can also make this setting on the computer (by, for example, choosing the media type in the RIP program you are using). When you have made the setting on the computer, the computer's setting is used and the printer's setting is ignored.

Default Setting

[PRE] (preheater): 45°C (112°F)

[PRINT] (print heater): 45°C (112°F)

Determining How the Preheater, Print Heater, and Dryer Operate

Procedure

- 1



Press **MENU** .
Press **▼** several times.
- 2



Press **▶** .
Use **▲** **▼** to make the setting.
Press **ENTER** to enable the setting.
- 3

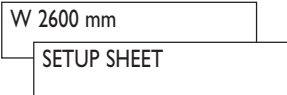

Press **MENU** .
Press **◀** to go back to the original screen.

Description

This feature lowers the temperature of the preheater, print heater, and dryer when the **SET UP** light is dark.

[MENU] performs heating to the preset temperature at all times, without lowering the temperature when the **SET UP** light is dark.

[PREHEAT] lowers the preheater and print heater to a fixed temperature when the **SET UP** light is dark. However, the dryer temperature is not lowered.

[OFF] switches off the preheater, print heater, and dryer when the **SET UP** light is dark.

Default Setting

[PREHEATING]: PREHEAT

4-7 Menu List

Main menu

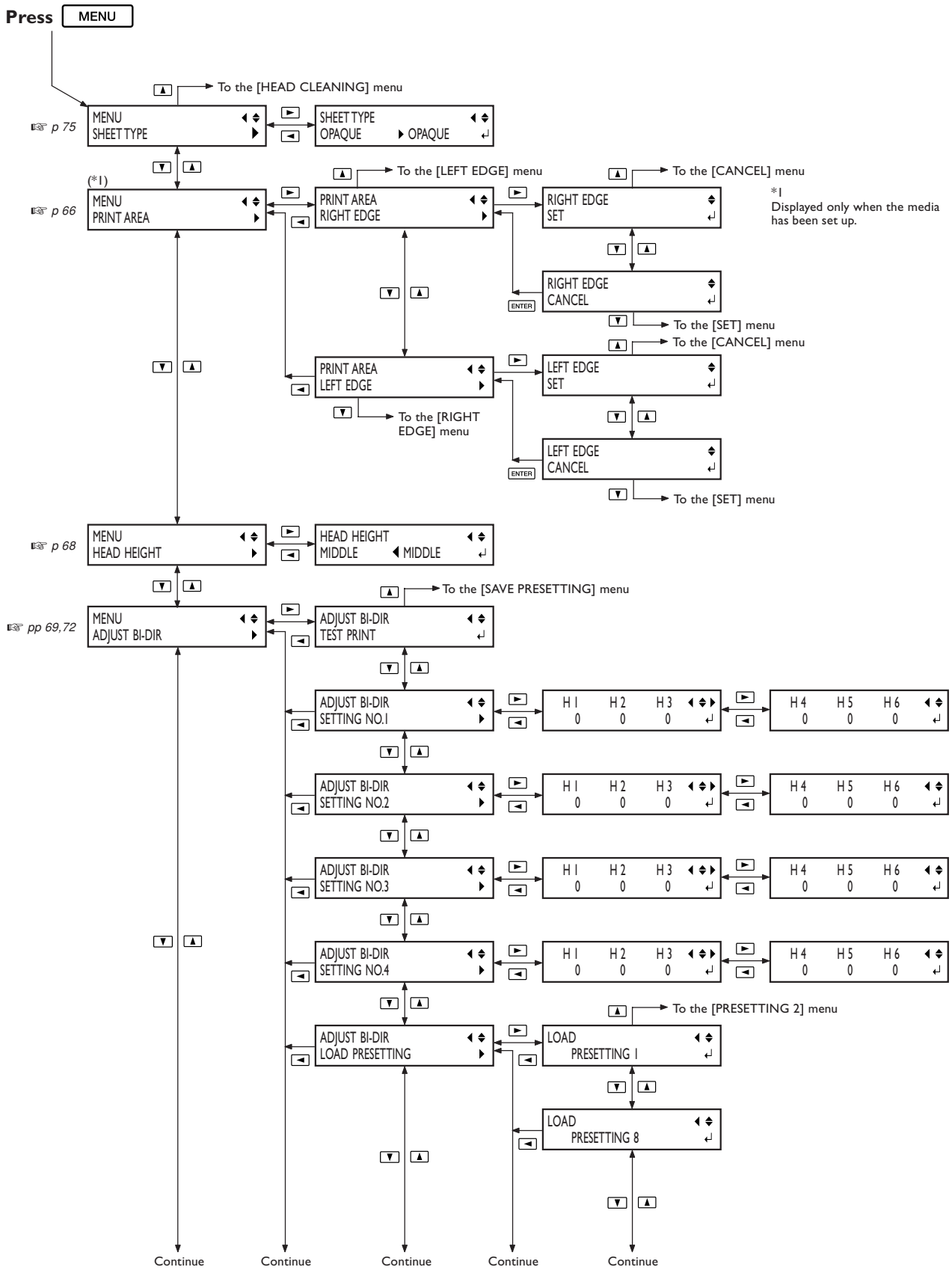

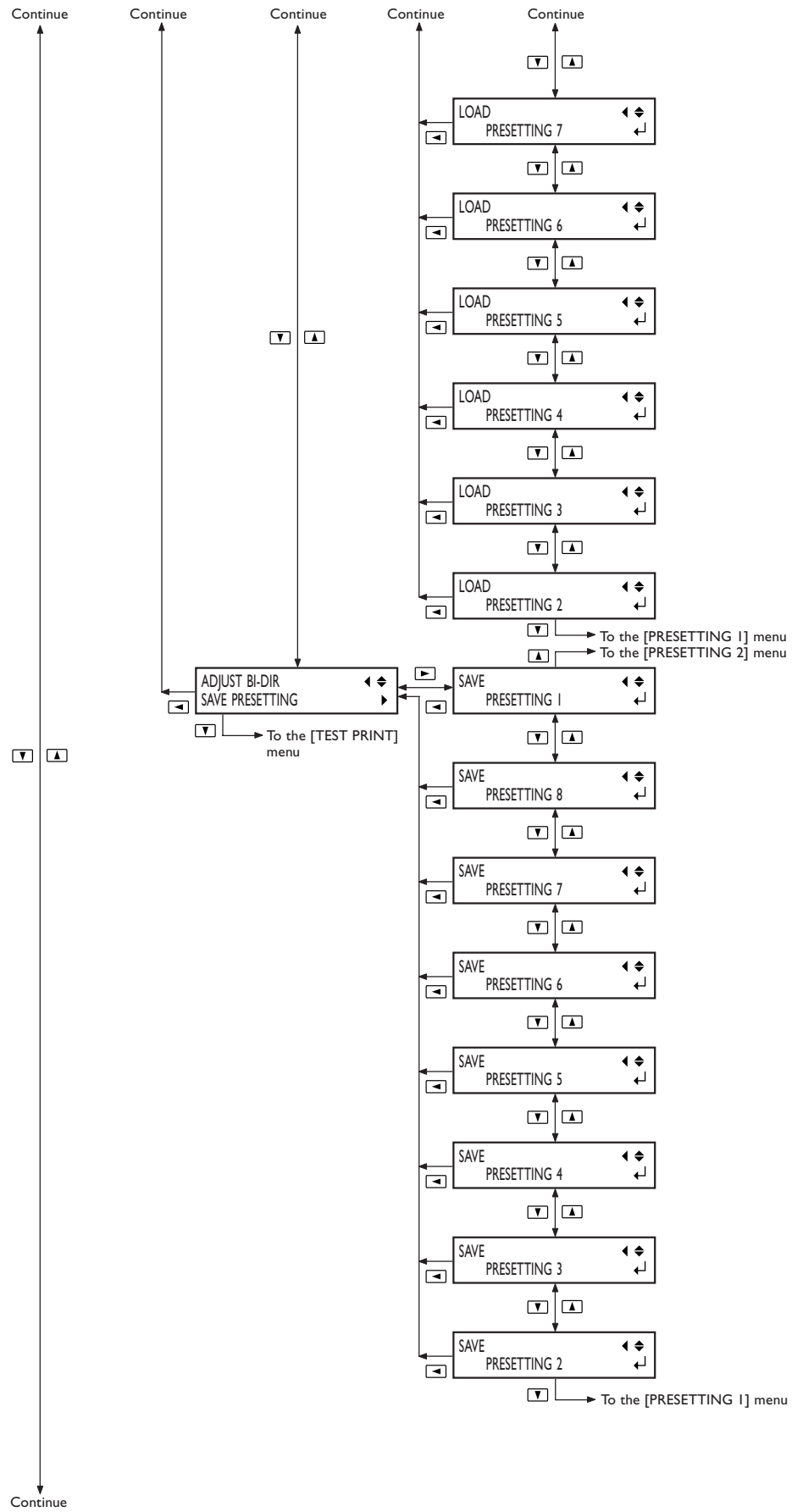

4-7 Menu List

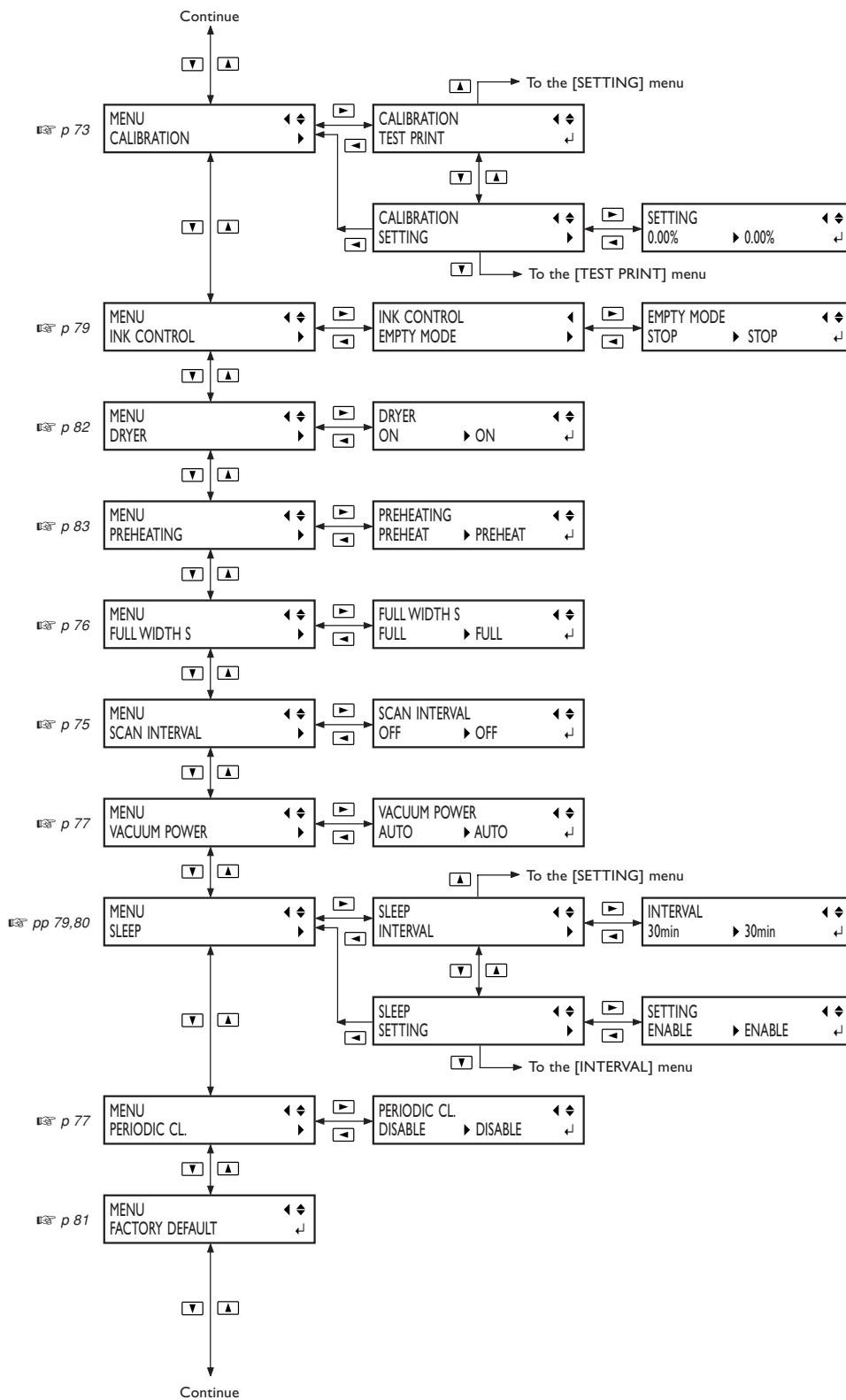

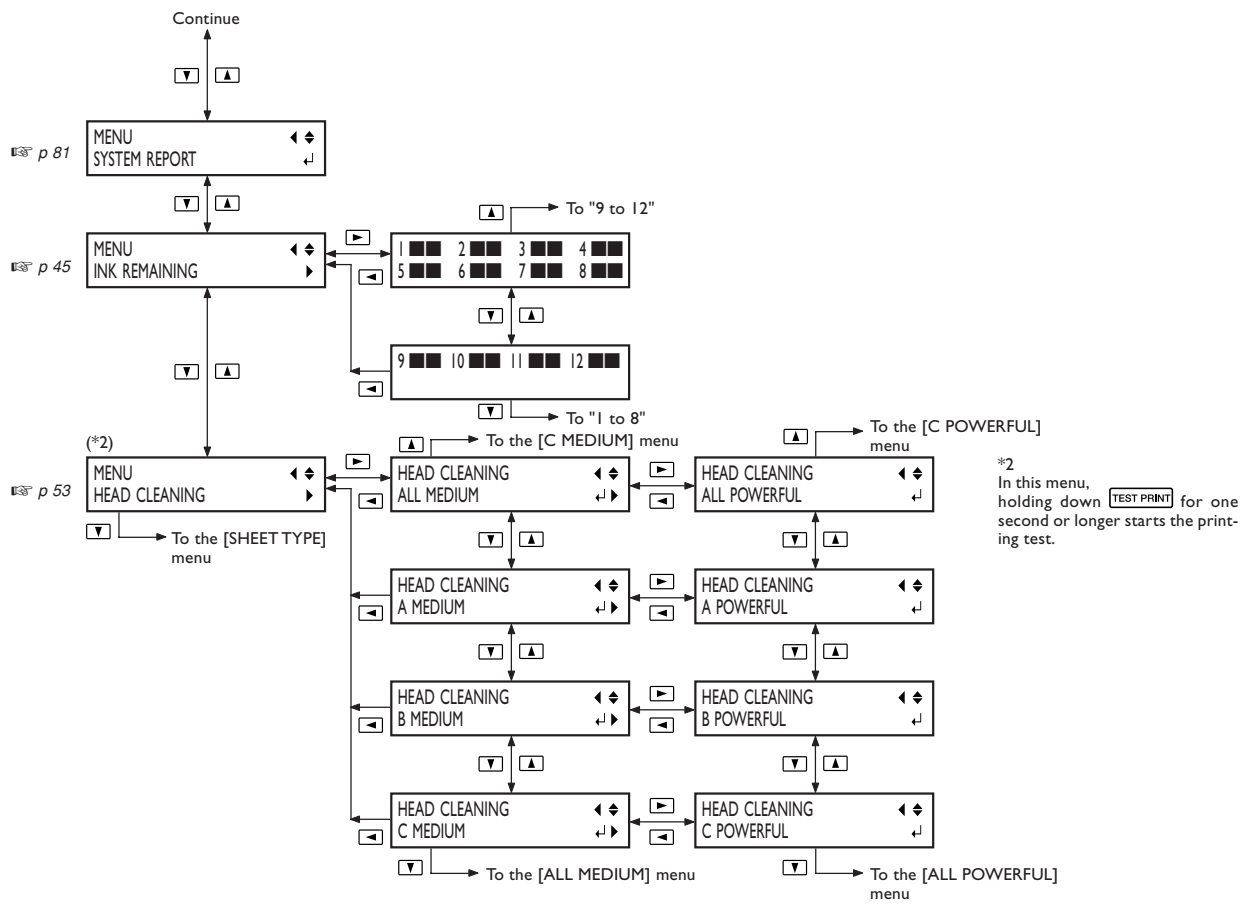

Language and Unit Menu

Hold down **MENU** and switch on the sub power.

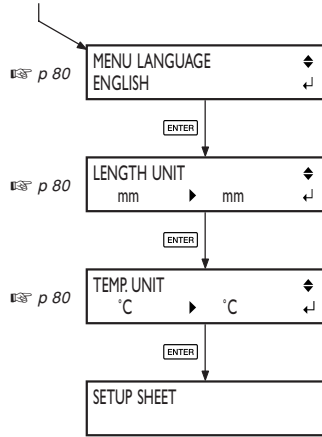

Cleaning and Maintenance Menu

Press **CLEANING**

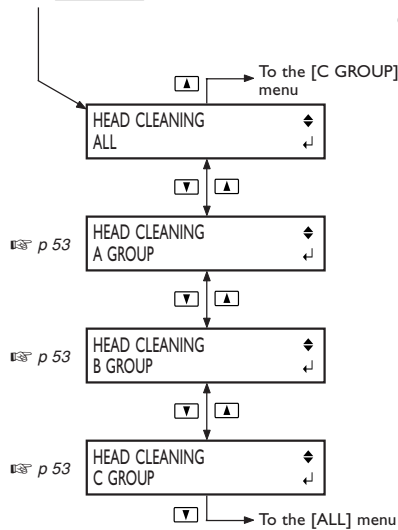

Hold down **CLEANING** for one second or longer.

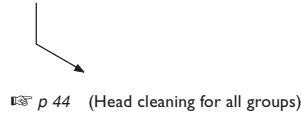

Hold down **CLEANING** and switch on the sub power.

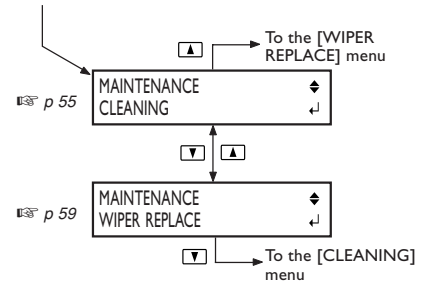

Heater Configuration Menu

Press **HEATER CONFIG**

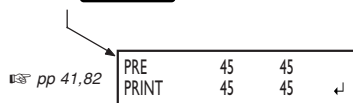

Chapter 5

What to Do If

5-1 The Machine Doesn't Run

The Printer Unit Doesn't Run

Is the power switched on?

Switch on the printer's main power, then press the sub power switch and make sure the POWER light comes on.



If the **SET UP** light on?

Printing is not performed when the **SET UP** light is not on. Pull back the loading lever, close the front cover, and press **SET UP**.

Is the front cover open?

Close the front cover.

Is the top menu displayed?

If the top menu isn't displayed, printing doesn't start even when data is sent from the computer. To go to the top menu, press **MENU**, then press . 

Is the **PAUSE** light on?

When the **PAUSE** light is on, operation is paused. To resume, press **PAUSE**. The **PAUSE** light goes dark and printing resumes.

Has ink run out?

When printing data is sent while the screen shown in the figure is displayed, a message appears and a warning beep sounds. At the same time, operation pauses.



When the ink cartridge is replaced with a new one, printing starts.

Is a message displayed on the screen?

☞ p 97 "If a Message Appears"

☞ p 98 "If an Error Message Appears"

Is the cable connected?

Connect the cable securely.

The Media Take-up or Feed System Doesn't Run

Is the power switched on?

Switch on both the printer's main power switch and the power switch for the take-up and feed units. To perform take-up and feed automatically during printing, also make the setting for the AUTO switch.

Is the cover closed securely?

The take-up and feed units do not operate unless the cover is securely closed.

Is media loaded correctly?

Make sure the media is passed through the guide roller and dancer rollers correctly.

The Dryer Doesn't Warm Up

Is the main power switch for the dryer turned on?

Turn on the main power switch for the dryer.

Are the menu settings enabled?

You can set the dryer on or off using the menu for the printer. Make sure the [DRYER] menu item is set to "ON." Also, the operation method changes according to the setting of the [PREHEATING] menu item.

☞ p 82 "Switching the Dryer On and Off"

☞ p 83 "Determining How the Preheater, Print Heater, and Dryer Operate"

Is the temperature of the room too low?

Use the machine in an environment where the temperature is 20 to 32°C (68 to 90°F).

Is the power supply the right voltage?

This machine requires 200 to 240 V power. Please note that it will not operate correctly at a lower voltage.

The Preheater and Print Heater Don't Warm Up

Is media loaded?

The preheater and print heater do not warm up to the preset temperature when the **SET UP** light is dark (unless the default setting has been changed). Load media, press **SET UP**, and wait for the machine to warm up.

☞ p 83 "Determining How the Preheater, Print Heater, and Dryer Operate"

Is the temperature of the room too low?

Use the machine in an environment where the temperature is 20 to 32°C (68 to 90°F).

Is the power supply the right voltage?

This machine requires 200 to 240 V power. Please note that it will not operate correctly at a lower voltage.

5-2 Attractive Printing Is Impossible

Printed Results Are Coarse or Contain Horizontal Stripes

Do the print heads show dot drop-out?

Carry out a printing test and make sure no dot drop-out occurs. If dot drop-out is present, perform head cleaning.

☞ p 44 "Printing Tests and Cleaning"

☞ p 53 "When Head Cleaning Is Not Effective"

Have you carried out feed correction?

Large misalignment in the amount of feed of the media may result in printing that seems coarse or contains horizontal stripes. Either make the setting on the computer to match the type of media you're using, or make the setting for correction on the printer.

☞ p 73 "Performing Feed Correction to Alleviate Horizontal Bands and the Like"

Have you carried out bidirectional correction?

When you are performing bidirectional printing, use the [ADJUST BI-DIR] menu item to carry out correction. The optimal adjustment value may vary, depending mainly on the thickness of the media. Set or select an adjustment value that is suited to the media.

☞ p 69 "Correcting for Misalignment in Bidirectional Printing"

Are the heating devices at a suitable temperature?

If the ink forms lumps or smudges, raise the temperature. Note, however, that a temperature that is too high may degrade the media or cause it to wrinkle.

☞ p 40 "Settings of Preheater, Print Heater and Dryer"

Is the temperature of the room too low?

The heating devices may not warm up sufficiently when the temperature is 20°C (68°F) or lower. Also, even when the heating devices reach their preset temperatures, adequate effectiveness may not be apparent if the media is thoroughly chilled. Before printing, allow the media to come to room temperature.

Is the print mode suitable?

When you are using uncoated media and attractive printing is not obtained even after you have raised the temperature of the preheater or print heater, try using a higher-quality print mode. Also, using the menu on the printer unit to make the setting for [SCAN INTERVAL] may improve printing quality.

☞ p 75 "Printing Hard-to-dry Media"

Depending on the media, smudging may occur when using a high-quality print mode, and results may also vary greatly depending on the settings of your RIP program (such as the color-profile selection). Make settings suited to the media you're using.

Is the printer installed in a level and stable location?

Never install the machine in a location where it is tilted

or where it may wobble or experience vibration. Also make sure that the print heads are not exposed to moving air. These factors may lead to missing dots or reduced printing quality.

Is the media loaded and set up correctly?

If the media is not loaded and set up correctly, media feed may not be smooth, or printing may be adversely affected.

☞ p 95 "Media Wrinkles or Shrinks, or Feed Is Unstable"

Colors Are Unstable or Uneven

Did you shake the ink cartridges gently before installing them?

Before you install a new ECO-SOL INK cartridge, gently shake the cartridge.

Is the media wrinkled?

If the media is wrinkled and comes loose from the platen, colors may be uneven or printing reduce may suffer.

☞ p 95 "Media Wrinkles or Shrinks, or Feed Is Unstable"

Was printing paused partway through?

When printing is paused, the coloring at the seam may be altered when printing resumes. Avoid pausing printing. With the factory-default settings, printing pauses when an ink cartridge runs empty. Before you perform lengthy printing, check the amount of ink remaining in the ink cartridges.

Printing may also pause when data is not sent from the computer quickly enough. We recommend not performing any other tasks with the computer while printing is in progress.

Are the operating parameters set to appropriate values?

Depending on the settings for such menu items as [FULL WIDTH S] and [PERIODIC CL.], uneven colors may occur. If the settings have been changed, try restoring them to their default values.

☞ p 76 "Speeding Up Printing for Narrow Media"

☞ p 77 "Keeping Media from Being Soiled by Ink Drips"

Is the printer installed in a level and stable location?

Never install the machine in a location where it is tilted or where it may wobble or experience vibration. Also, ensure that the printing heads are not exposed to wind or blown air. These factors may lead to missing dots or reduced printing quality.

The Media Becomes Soiled When Printed

Do the print heads contact the media?

The height of the print heads may be too low. Also, if the media is not loaded and set up correctly, it may wrinkle or come loose and strike the heads.

- ☞ p 95 "Media Wrinkles or Shrinks, or Feed Is Unstable"
- ☞ p 68 "Adjusting Head Height to Match Media Thickness"

Are the print heads dirty?

The following may cause ink to drip on the media during printing.

- Buildup of fibrous dust (lint) around the heads
- Ink transferred to the heads due to rubbing against the media.

If this happens, clean the heads using the cleaning kit. We recommend carrying out periodic head cleaning.

- ☞ p 55 "Cleaning the Heads Using the Cleaning Kit"

Are the pinch rollers dirty?

Periodically clean the pinch rollers.

5-3 The Media Jams

The Media Jams

If an error message is displayed because the media has jammed, immediately correct the problem. Failure to do so may damage the print heads.

☞ p 98 [MOTOR ERROR TURN OFF POWER]

Is the media warped or wrinkled?

Many factors can cause warping or wrinkling. Refer to the following and correct the problem.

☞ p 95 "Media Wrinkles or Shrinks, or Feed Is Unstable"

Is the height of the print heads too low?

Try raising the heads higher. Media may inevitably warp or wrinkle slightly, so adjust the height of the heads to take this into account.

☞ p 68 "Adjusting Head Height to Match Media Thickness"

5-4 The Media Cannot Be Taken Up Smoothly

The Media Cannot Be Taken Up Smoothly

Is media feed unstable?

Various factors can make media feed unstable. Refer to the following and correct the problem.

- ☞ p 95 "Media Wrinkles or Shrinks, or Feed Is Unstable"

5-5 Media Wrinkles or Shrinks, or Feed Is Unstable

A variety of problems can occur if the media feed is not smooth. This can cause such problems as poor printing quality, contact with the media by the print heads, misaligned positioning, media jams, or poor take-up. Take action as follows.

Media Wrinkles or Shrinks

Is the media loaded and set up straight and securely?

Feed is not smooth when the media is not straight or tensioned unevenly on the left and right. Reload the media.

Are the feed dancer rollers level?

If they are not level, the media may become crooked or wrinkle. Adjust the position of the balance weights to match the width of the media.

Is media loaded correctly?

Make sure the media is passed through the guide roller and dancer rollers correctly.

Are the media clamps mounted?

Be sure to attach the media clamps.

Was loaded media allowed to stand for some time?

Media may shrink or wrinkle if it is heated for an extended time. When printing ends, switch off the sub power or remove the media.

Was the media loaded while the heating devices were hot?

Loading media after the heating devices have warmed up causes the temperature of the media to rise suddenly, which may cause the media to shrink or wrinkle during printing. Before loading media, switch off the sub power and allow them to cool.

Is the temperature of the heating devices too high?

Set the temperature to suitable values for the type of media.

☞ p 40 "Settings of Preheater, Print Heater and Dryer"

Is the roll media sagging?

Sagging of the roll can cause wrinkling or warping. Attach the reinforcement pipe when loading the media. Also, when storing media, place it so that it will not sag under its own weight.

The Media Is Not Straight

Is the media loaded and set up straight and securely?

Feed is not smooth when the media is not straight or tensioned unevenly on the left and right. Reload the media.

Are the feed dancer rollers level?

If they are not level, the media may become crooked or wrinkle. Adjust the position of the balance weights to match the width of the media.

Is media loaded correctly?

Make sure the media is passed through the guide roller and dancer rollers correctly.

Media Feed Is Not Smooth

Do the media or the dancer rollers strike some other object?

Make sure the media and the dancer rollers do not touch anything else. This may affect printing, even when feed appears to be smooth.

Is the media too thick?

Media that is too thick may not only cause unstable feed, but may scrape the print heads, resulting in malfunction. Never use such media.

Are the grit rollers dirty?

Check to make sure the grit rollers are free of buildup of foreign material such as media scraps.

5-6 The Print Heads Stopped Moving

If the print-head carriage stops over the platen, take action immediately to prevent the heads from drying out.

What to Do First

Switch the sub power off, then back on again. (If the media is jammed, then also remove the media.) If the heads move to the standby position (inside the right side cover), it means the operation has ended successfully. If the heads did not move, try switching off the main power, then again switching on the main power, followed by the sub power.

If the Heads Still Do Not Move

If the heads still do not move, carry out the following emergency response measure, then contact your authorized Roland DG Corp. dealer or Roland DG Corp. service center.

1. Switch off the main power and detach the right side cover.
2. Open the front cover.
3. Gently move the print heads by hand as far as the standby position.

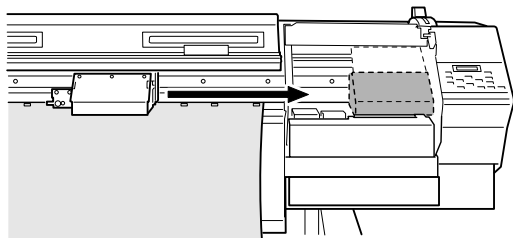

4. Insert the cap-unit tool into the hole at the bottom of the machine and turn gently. The cap unit rises.

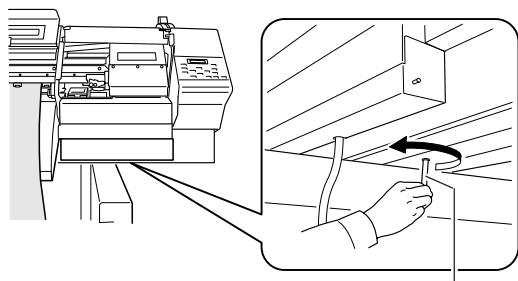

Cap-unit tool

5. Make the guides at the edges of the print heads line up with the printing heads at the edges of the cap unit. Turn the tool further to bring the heads near the cap unit.

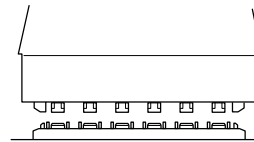

6. When the heads make contact with the cap unit, turn the tool one or two more turns.



Make sure the print heads are capped tightly.

5-7 If a Message Appears

These are the main messages that appear on the machine's display to prompt correct operation. They do not indicate any error. Follow the prompts and take action accordingly.

[1 ■ 2 ■ 3 ■ 4 ■ ...]

Only a small amount of ink remains. Replace the cartridge indicated by the flashing number with a new cartridge.

[CLOSE THE COVER]

Close the front cover and the left and right side covers. For safety, the carriage does not operate while a cover is open.

[DO NOT USE MEDIA CLAMPS]

Make sure the media clamps have been removed. The media clamps cannot be used when the height of the print heads is set to "Low." (Using them may cause malfunction.) After verifying, press **ENTER**.

[EMPTY DRAIN BOTTLE]

Detach the drain bottle from the machine, discard the discharged fluid, then reinstall the drain bottle on the machine. Press **ENTER** to continue. This message appears before operations that discharge a large amount of ink.

[INSTALL DRAIN BOTTLE]

Check whether the drain bottle is installed. Install the drain bottle, then press **ENTER**.

[NOW HEATING...]

Wait until the preheater and print heater reach the preset temperature. Printing starts when the preset temperature is reached.

You can stop printing by holding down **SET UP** for one second or longer while this is displayed. Pressing **PAUSE** makes printing start immediately, without waiting to reach the preset temperature.

[PRESS THE POWER KEY TO CLEAN]

This appears when the machine has been unused for about one month. Switch on the sub power once a month.

☞ p 61 "When Not in Use for a Prolonged Period"

[REMOVE SOL CL]

Remove the cleaning cartridge indicated by the flashing number. This message appears at times such as during head cleaning.

[REMOVE SOL CRT.]

Remove the ink cartridge indicated by the flashing number. This message appears at times such as during head cleaning.

[SET SOL CRT.]

Insert the ink cartridge indicated by the flashing number. This message appears at times such as during cartridge replacement.

[SET SOLCL-LIQUID]

Insert the cleaning cartridge indicated by the flashing number. This message appears at times such as during head cleaning.

[SHEET NOT LOADED PRESS SETUP KEY]

Load media and press **SET UP**. This message appears when an attempt to perform a printing test was made while no media was loaded.

[TIME FOR MAINTENANCE]

It is time to clean the heads using the cleaning kit. After verifying, press **ENTER**.

☞ p 55 "Cleaning the Heads Using the Cleaning Kit"

[TIME FOR WIPER REPLACE]

It is time to replace the wiper. After verifying, press **ENTER**.

☞ p 59 "Replacing the Wipers"

5-8 If an Error Message Appears

This describes the error messages that may appear on the machine's display, and how to take action to remedy the problem. If the action described here does not correct the problem, or if an error message not described here appears, contact your authorized Roland DG Corp. dealer or Roland DG Corp. service center.

[AVOIDING DRY-UP TURN OFF POWER]

The print heads were forced to standby position to prevent them from drying out.

Operation cannot be continued. Switch the sub power off, then back on. Opening the front cover while printing is in progress causes an emergency stop. Never allow the print heads to stand in this state.

[CANCELED FOR PROTECTING MOTOR]

Continuous operation made the pump motor become hot, and so operation was paused.

Press any key to clear the error. Allow the machine to stand for approximately 40 minutes, then resume operation.

[DATA ERROR CANCELING...]

Output was stopped because a problem was found in the data received.

Operation cannot be continued. Check for problems with the connector cable or the computer, then redo the operation, starting with reloading the media.

[HEAD HEIGHT ERROR]

The height-adjustment lever for the print heads was operated improperly.

Operation cannot be continued. Switch the sub power off, then back on. To change the head height, use the [HEAD HEIGHT] menu.

☞ p 68 "Adjusting Head Height to Match Media Thickness"

[HEATING TIMEOUT CONTINUE?]

The preheater or print heater did not reach the pre-set temperature.

This occurs because the temperature of the location where the machine is installed is too low. We recommend raising the temperature. To quit printing, hold down **[SET UP]** for one second or longer. To continue waiting for the temperature to rise, press **[ENTER]**. To start printing immediately, press **[PAUSE]**.

[MOTOR ERROR TURN OFF POWER]

A motor error occurred.

Operation cannot be continued. Switch off the sub power. Next, eliminate the cause of the error, then immediately switch on the sub power. If the machine is allowed to stand with the error uncorrected, the print heads may dry out and become damaged.

This error may be caused by such factors as a mistake in loading the media, a media jam, or an operation that pulls the media with excessive force.

The media is loaded incorrectly.

Check how the media is threaded through the rollers. Also make sure the AUTO switches for the feed and take-up units are set correctly.

The media has jammed.

Carefully remove the jammed media. The print heads may also be damaged. Perform head cleaning, then perform a printing test and check the results.

The media was pulled with excessive force.

Excessive tension was applied to the media, and additional action is necessary to recover from this state. First, move the loading lever to the rear and open the cover for the feed and take-up units. Adjust the media to create a small amount of slack, then switch on the sub power.

[PINCHROLL ERROR LOWER PINCHROLL]

[SET UP] was pressed without first lowering the pinch rollers.

Press any key to clear the error. Pull back the loading lever, then press **[SET UP]**.

The pinch rollers were raised while the [SET UP] light was on.

The error is cleared automatically after a short wait. Never move the loading lever while printing is in progress.

[SERVICE CALL xxxx]

An unrecoverable error occurred, or part replacement that must be performed by a service technician is required.

Note the number displayed, then switch off the sub power. After you switch off the power, inform your authorized Roland DG Corp. dealer or Roland DG Corp. service center of the number that appeared on the display.

[SET HEAD HEIGHT TO xxxx]

The height of the print heads is lower than the height specified on the computer.

This warning indicates that the height of the print heads

is too low for the media thickness specified on the computer. The heads move to a location where you can operate the height-adjustment lever. Adjust to the displayed height, then press **ENTER** .

[SHEET SET ERROR SET AGAIN]

SET UP was pressed even though no media is loaded. Press any key to clear the error. Load media and pull back the loading lever, then press **SET UP** .

Transparent media was loaded even though [SHEET TYPE] is set to [OPAQUE].

Press any key to clear the error. Set the [SHEET TYPE] menu item to [CLEAR], then reload the media.

☞ p 75 "Using Transparent Media"

The positioning of the loaded media is displaced to the left.

Press any key to clear the error. Reload the media at the correct position, then press **SET UP** .

The loaded media is too small.

Press any key to clear the error. Replace with media of usable size.

The platen is dirty.

Press any key to clear the error. The machine cannot sense the width of the media because of soiling. Clean the platen.

The media clamps are mounted at the wrong locations.

Press any key to clear the error. The media clamps are intended to clamp the edges of the media. Reattach them at the correct locations.

[TEMPERATURE IS TOO HIGH]

The temperature of the location where the machine is installed has risen above the ambient temperature at which the machine can operate.

Operation cannot be continued. Switch off the sub power. Bring the installed location to a temperature at which operation is possible (20 to 32°C), then turn on the power.

[TEMPERATURE IS TOO LOW]

The temperature of the location where the machine is installed has fallen below the ambient temperature at which the machine can operate.

Operation cannot be continued. Switch off the sub power. Bring the installed location to a temperature at which operation is possible (20 to 32°C), then turn on the power.

[WRONG CARTRIDGE]

A cartridge that cannot be used was installed.

Remove the cartridge to clear the error. Use a cartridge of the specified type.

A cartridge was inserted with too much force.

Remove the cartridge to clear the error. Insert and remove cartridges slowly and gently, one at a time.

[WRONG WIDTH UNDER 1220 (or 48)]

The width of the loaded media is too narrow.

Press **ENTER** to clear the error. Replace with media of usable size.

Chapter 6

Specifications

6-I Usable Media

Conditions for Usable Media

Media width

48 to 104 inches (1220 to 2641 mm)

Roll outer diameter (A)

Maximum 250 mm (9.8 inches)

Paper pipe (core) inner diameter (B)

3 inches (76.2 mm)

Media thickness (C)

Maximum 1.0 mm (39 mil)

Roll weight

Maximum 100 kg (220 lb.)

Other conditions

Media such as the following cannot be used.

- Media whose end is attached to the paper pipe (core)
- Media which is severely warped or which has a strong tendency to reroll
- Media that cannot withstand the heat of the heating devices
- Media that cannot withstand the tensioning of the media take-up or feed system
- Media whose paper pipe (core) is bent or crushed
- Media that bends under its own weight when loaded

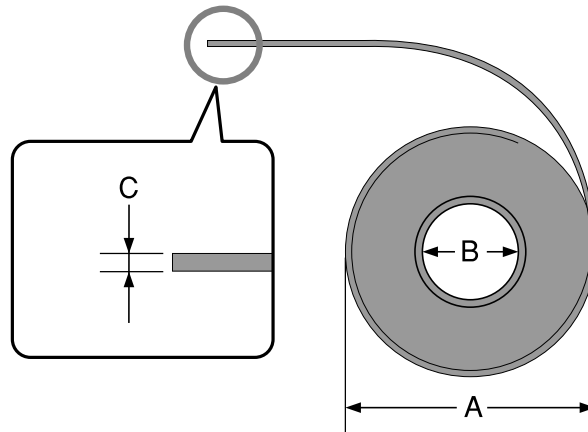

This machine cannot necessarily print every kind of media. When selecting media, be sure to carry out testing in advance to make sure that satisfactory printing quality is obtained.

6-2 Printing Area

Printing Area and Margins

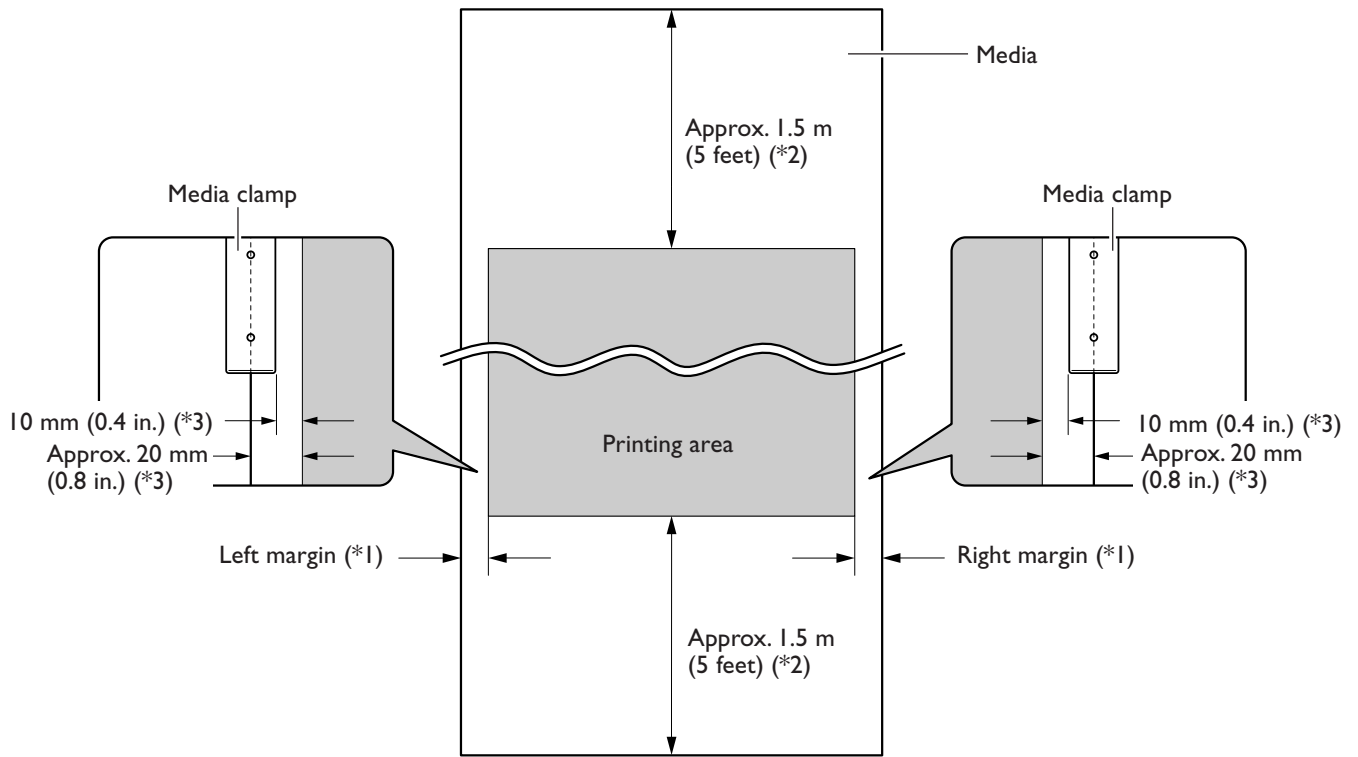

*1 The amount of margin can be changed using the menus.

*2 Margin length required by the media take-up and feed systems.

*3 Margin set automatically (default value; for media whose width is detectable)

6-3 Locations of the Power Rating and Serial Number Labels

Serial Number

This is require when you seek maintenance, servicing, or support. Never peel off the label or let it get dirty.

Power Rating

Use an electrical outlet that meets the requirements for voltage, frequency, and amperage given here.

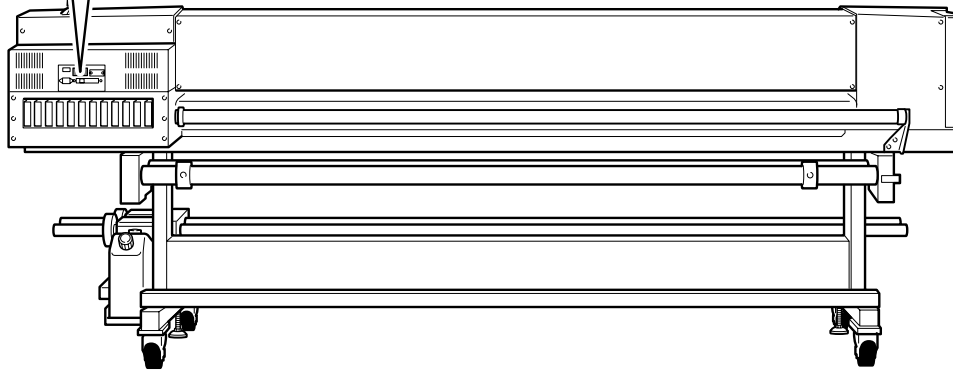

6-4 Specifications

		SJ-1000
Printing method		Piezo ink-jet method
Loadable media width		1220 to 2641 mm (48 to 104 in.)
Printable area		Maximum width: 2600 mm (102.3 in.)
Ink	Type	Exclusive ECO-SOL INK
	Colors	4 colors (cyan, magenta, yellow, and black)
Resolution		Maximum 1440 dpi
Printing speed		Maximum approx. 45 m ² /h
Distance accuracy		Error of less than ±0.3% of distance traveled, or 0.3 mm, whichever is greater (at SV-G-1270G, print travel: 1 m, temperature: 20°C (68°F), humidity: 50%, PRE and PRINT heater temperature setting: 40°C (104°F))
Media take-up system	Roll outer diameter	Maximum 250 mm (9.8 in.)
	Roll weight	Maximum 100 kg (220 lb.)
Media feed system	Roll outer diameter	Maximum 250 mm (9.8 in.)
	Roll weight	Maximum 100 kg (220 lb.)
Media dryer		Heating method
Ink-fixing device		Preheater and print heater
Interface		Ethernet (10BASE-T/100BASE-TX, automatic switching)
Power-saving function		Automatic sleep (compliant with the International ENERGY STAR® Office Equipment Program)
Power supply	Voltage and frequency	AC 200 to 240 V ±10%, 50/60 Hz
	Required power capacity	10 A
Power consumption	During operation	Approx. 2400 W
	Sleep mode	Approx. 55 W
Acoustic noise level	During operation	65 dB (A) or less (according to ISO 7779)
	During standby	40 dB (A) or less (according to ISO 7779)
Dimensions		3894 (W) x 1159 (D) x 1394 (H) mm (153.4 (W) x 45.7 (D) x 54.9 (H) in.)
Weight		455 kg (1003 lb.)
Environment	Power on (*)	Temperature: 20 to 32°C (68 to 89.6°F), humidity: 35 to 80% (no condensation)
	Power off	Temperature: 5 to 40°C (41 to 104°F), humidity: 20 to 80% (no condensation)
Included items		Power cord, roll shafts, end caps, spacers, media reinforcement pipe, paper pipe, drain bottle, media gauge, media clamps, hexagonal wrenches, cap-unit tool, cleaning kit, cleaning liquid cartridges, software RIP, Roland-PrintServer CD-ROM, User's Manual, Setup Guide, Roland-PrintServer Network Settings Guide

* Environment

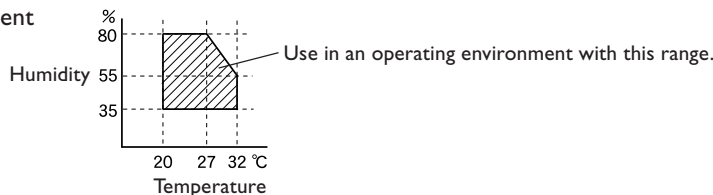



26015470-R2

R2-040617